



## Hydra

Networked embedded system middleware for  
heterogeneous physical devices in a distributed architecture

### **D3.1 Existing applications, services, devices and standards**

---

Integrated Project  
SO 2.5.3 Embedded systems

**Project start date: 1st July 2006**

**Duration: 48 months**

**Published by the Hydra Consortium**

**2007-02-20 - version 1.0**

**Lead Contractor: CNet Svenska AB**

**Project co-funded by the European Commission  
within the Sixth Framework Programme (2002 -2006)**

**Dissemination Level: Confidential**

**Document file:** D3.1\_v10.doc

**Work package:** WP3 – Architecture Design Specification

**Task:** T3.1 - Analysis of existing applications, services, devices and standards: Gather, analyse and harmonise existing devices, services, standards, systems and applications.

**Document owner:** CNet Svenska AB

**Document history:**

<b>Version</b>	<b>Author(s)</b>	<b>Date</b>	<b>Changes made</b>
0.2	Matts Ahlsén, Peter Rosengren	10-10-2006	Initial structure defined
0.3	Matts Ahlsén, Peter Rosengren	04-11-2006	Updates before WP3 kick-off meeting
0.5	Matts Ahlsén, Peter Rosengren. Peeter Kool, Pablo Antolin Rafael	20-12-2006	Chapter on KNX and other standards added. Appendix on intelligent homes added.
0.7	Matts Ahlsén, Peter Rosengren. Peeter Kool, Pablo Antolin Rafael, Klaus Marius Hansen	21-12-2006	Chapter on devices in agriculture added
0.9	Matts Ahlsén, Peter Rosengren. Peeter Kool, Pablo Antolin Rafael, Klaus Marius Hansen	18-01-2007	Conclusions added
0.95	Matts Ahlsén, Peter Rosengren. Peeter Kool, Pablo Antolin Rafael, Klaus Marius Hansen	19-01-2007	Peer-reviewed by FIT. Documented updated.
0.99	Matts Ahlsén, Peter Rosengren. Peeter Kool, Pablo Antolin Rafael, Klaus Marius Hansen	20-02-2007	Peer-reviewed by FIT (second round) and T-CON. Documented updated.
1.00	Matts Ahlsén, Peter Rosengren. Peeter Kool, Pablo Antolin Rafael,	21-02-2007	Final version submitted to EU commission.

	Klaus Marius Hansen		
--	---------------------	--	--

**Internal review history:**

<b>Reviewed by</b>	<b>Date</b>	<b>Comments</b>
Marius Scholten, FIT	19-01-2007, 20-02-2007	
Guiseppe Menta, T-CON	20-02-2007	

**Index:**

<b>1 Introduction</b> .....	<b>5</b>
1.1 Purpose, context and scope of this deliverable .....	5
1.2 Hydra Middleware.....	5
<b>2 Executive summary</b> .....	<b>7</b>
<b>3 Applications</b> .....	<b>8</b>
3.1 Building Automation .....	8
3.2 eHealth and Home Care .....	9
3.3 Agriculture .....	10
<b>4 Devices</b> .....	<b>13</b>
4.1 Building automation systems and devices .....	13
4.1.1 Home Automation .....	15
4.1.2 Room Automation .....	18
4.1.3 Intelligent Buildings .....	18
4.2 Healthcare.....	19
4.2.1 Medical devices in Hydra .....	19
4.2.2 Sample devices .....	19
4.3 Agriculture .....	21
4.3.1 Cattle.....	22
4.3.2 Machines and plant production.....	26
<b>5 Standards</b> .....	<b>32</b>
5.1 X10 .....	33
5.1.1 X10 Protocol .....	33
5.2 EIB/KNX .....	34
5.2.1 The KNX Standard: Communication media.....	35
5.3 Universal Plug and Play (UPnP).....	36
5.4 Device description .....	37
5.4.1 Classifying and registration of medical devices .....	39
<b>6 Conclusions</b> .....	<b>41</b>
6.1 Towards a Hydra Device Ontology.....	41
6.1.1 Basic considerations .....	42
6.1.2 Design considerations.....	43
6.1.3 Implementation considerations .....	43
<b>7 References</b> .....	<b>45</b>
<b>Appendix A: Casa Domótica – an Example of Intelligent Homes</b> .....	<b>46</b>
<b>Appendix B: Automation Products and Suppliers</b> .....	<b>59</b>
<b>Appendix C: European Home automation manufacturer overview</b> .....	<b>68</b>

# 1 Introduction

## 1.1 Purpose, context and scope of this deliverable

The Hydra project is researching and developing middleware for heterogeneous physical devices in a distributed architecture. It will also deliver development tools for solution providers of ambient intelligent applications using such devices. Furthermore a third result will be tools for device producers to enable their devices to be part of an ambient intelligent environment.

The purpose of this deliverable is to assess and survey best practice, the extent to which automated solutions are already in place and what kind of intelligent devices are already in use in various application areas. This will provide background for understanding the heterogeneity of different services, devices and systems that the Hydra middleware will interface with, especially in our selected target application areas. The work is based on task 3.1, "Analysis of existing applications, services, devices and standards". The task has aimed at gathering, analysing and harmonising existing devices, services, standards, systems and applications.

This deliverable complements deliverable D2.2 Technology Watch (Hydra 2006a), which describes state-of-the-art in various important research areas.

The deliverable will provide input to workpackage 6 and will suggest a starting point for developing the device ontology. It will also feed into workpackage 9 with requirements for the specific prototypes to be built.

The context for this report is set by the user requirements specification process and results carried out in workpackage 2.

## 1.2 Hydra Middleware

The purpose of middleware is to hide the complexity and bridge the heterogeneity of an underlying distributed computational infrastructure and for applications running on that infrastructure. The functions of the middleware are to simplify and provide enhanced development functions for application developers, and to support various run-time capabilities such as security, fault tolerance and localization.

Middleware can then, in principle, be any software that makes up the architecture layer between the distributed infrastructure and the applications using it.

The evolution of software into the current middleware design can be traced back to the first transaction managers/monitors.

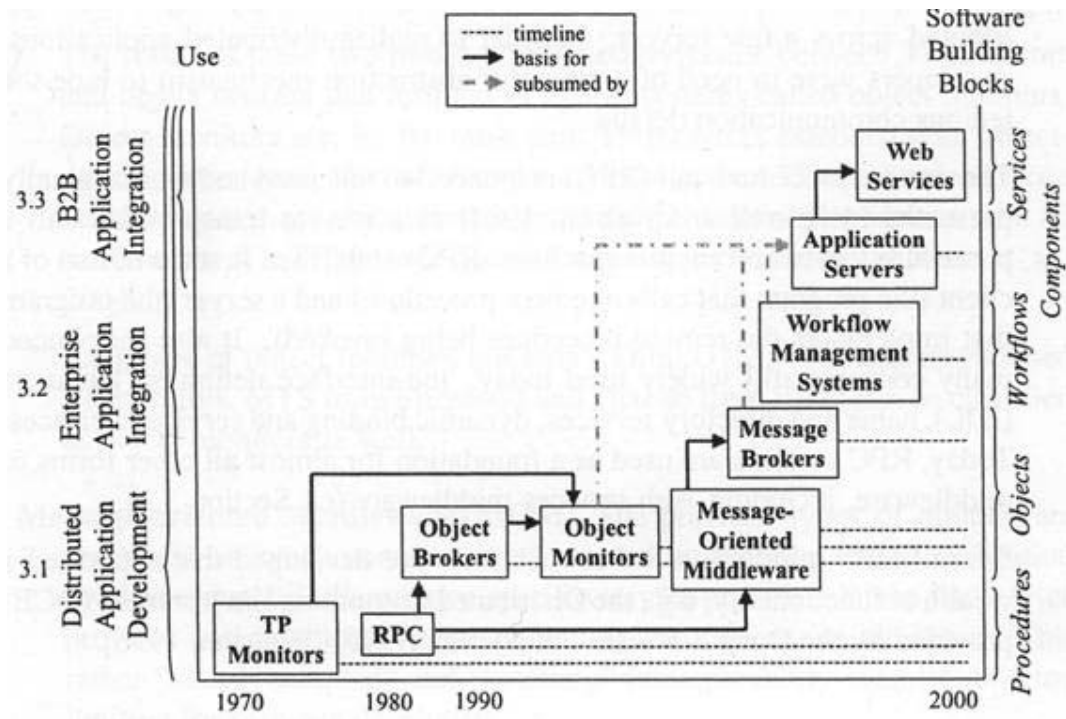

Fig. 1.1: Evolution of middleware (from Oberle 2006).

The evolution of middleware technologies has also brought on new systems building block abstractions (Fig. 1.1), which of course have implications on the design, the deployment and the execution of new middleware solutions.

## 2 Executive summary

The Hydra project is researching and developing middleware for heterogeneous physical devices in a distributed architecture. It will also deliver development tools for solution providers of ambient intelligent applications using such devices. Furthermore a third result will be tools for device producers to enable their devices to be part of an ambient intelligent environment.

This deliverable assesses and surveys best practice, the extent to which automated solutions are already in place and what kind of intelligent devices are already in use in three application areas - *Building automation, eHealth and Agriculture*.

The deliverable starts with a discussion on the current situation in the three mentioned application domains and the drivers for introducing more automation.

It then describes and categorises typical devices in each field. Further it provides a description and analysis of existing standards relevant for device automation.

Finally, the deliverable concludes by discussing considerations that need to be taken into account when designing a device ontology which will form an integral part of the Hydra middleware. It provides a framework for classifying and describing devices given a set of classification dimensions, which are considered relevant for developers using the Hydra middleware. Three levels of device intelligence are defined – remote controlled devices, rule-based device control and intelligent automation.

This deliverable is a starting point for defining and specifying the Hydra device ontology

## 3 Applications

The Hydra project has decided to validate its results in three different application domains, which have been selected to illustrate the use of embedded systems in automation tasks. The three application domains are Building Automation, eHealth and Homecare, and Agriculture. In this section we will give a brief overview of the situation with regards to embedded systems and automation.

We refer to deliverable D2.1 on the scenario development (Hydra 2006b) for a more detailed discussion on each application domain including various usage scenarios.

### 3.1 Building Automation

One generally accepted definition of intelligent building technologies is "...integrated technological building systems, communications and controls to create a building and its infrastructure which provides the owner, operator and occupant with an environment which is flexible, effective, comfortable, and secure".

The availability of new ICT<sup>1</sup> solutions imposes a dramatic enrichment of the capability of Building Automation components and systems. The expectation among facility owners and managers is that control systems can be integrated and provide a high level of "building intelligence." This concept speaks to managing facilities as assets transforming building data into knowledge and using that to make intelligent business decisions in real time. The driver of building intelligence and many other major trends is economic pressure to increase efficiency and productivity continuously and to do more with less. Another major trend in building automation is the need for improved security systems, which can be supported by smart and integrated building automation systems. In addition to this, facility management agreements are more and more based on incentives about savings: this implies that facility managers strive to find opportunities for savings in order to share them with the end-users. For the consumer, the availability of affordable home networking interconnecting computers, media and entertainment systems, implies that a growing number of consumer electronic products (devices) should be part of solutions that aim to realize the concepts of the "intelligent home" or the "smart house". In this area we will also see the emergence of new service providers and application developers as important actors in intelligent/smart home solutions (CENELEC 2005).

The trends affect both major players in the Building Automation market: The *users* (facility managers) and the *suppliers* (components manufacturers and industrial services companies).

The facility managers want plug-and-play interoperability. In fact, the concept of interoperability for facility executives can be traced back to three elements:

- Harmonic coexistence: in this case, facility executives want for their buildings are products from different manufacturers that operate independently without interfering with each other.
- Interchangeability: in this definition of interoperability, all chillers operate so identically, that only the nameplate distinguishes one from another
- Integration, that allows for individuality: most facility executives, however, want interoperability somewhere between these two extremes. They want plug-and-play interoperability. They want products that can be integrated easily without using custom hardware or software. But they also want to leave room for supplier differences within product lines.

Facility managers are pushing Building Automation systems vendors to transform today's closed technologies into Web-enabled applications. Facility managers are driving Building Automation systems by demanding open systems. The open architecture approach means widespread acceptance and sharing of hardware and software designs, standards, and protocols and is seen as

---

<sup>1</sup> Information and Communication Technology



being critical to the successful spread of intelligent building technology. It will lead to a greater interoperability of various systems.

Most product companies will thus soon realise that device networking isn't only possible, it's essential for their future business. Moreover, in a market where customers continuously ask for more complex and integrated services, it clearly results that these new applications and intelligent solutions can help to reduce the risk that product companies take by assuming a greater and greater management responsibility (from simple installation to global service).

A major challenge for most existing Building Automation systems is that they are not wireless. Consequently they are primarily installed in new buildings. Specialists must do all configurations and systems cannot be remotely controlled. Many users do not find that these systems give sufficient value for money. Consequently, the market today is quite limited, but with a great potential in existing buildings, once the proper products are introduced. By deploying an industry-wide Hydra middleware, all products can be service-enabled and made interoperable with just a few device drivers and supporting models for interoperable functions.

A survey conducted by the Wireless LAN Association and NOP World Technology showed that the average payback for a wireless installation is about nine months. The survey also concluded that the average wireless user is 22% more productive than his or her wired counterparts. Productivity benefits are quantified at 48% of the total return on investment of a wireless network.

### **3.2 eHealth and Home Care**

Improving citizens' access to healthcare implies both an urge for organizational change as well as the development of technology supporting mobile use and decentralized service provision. The Hydra project has chosen healthcare as one of its application domains. This is an area in which the adoption of ambient intelligence based device networks and middleware should promote the deployment of mobile, distributed and standards based applications, capable of meeting the changing healthcare requirements. As the population of Europe is growing older it will require more care, while at the same time the number of people with chronic diseases is also increasing across Europe. These are two of the factors that will increase the need for mobile and in-home healthcare services. Trends pointing in this direction are seen in many member states through initiatives to promote primary care, out-patient care, reduction of hospital beds and length of hospital stays in order to reduce the use and costs of healthcare resources (eu-DOMAIN, 2006).

For many years healthcare has been held as an area to be leveraged by the deployment of Internet based applications and e-services. Both private and public healthcare providers are under pressure to provide efficient, cost-effective health services and care to citizens thru the use of e-services based on new and emerging technologies. The increasingly widespread deployment of ICT as a core component, including high-capacity communication infrastructures, facilitates the delivery of ubiquitously and enhanced health care services to citizens in clinical care as well as in their homes.

An important factor is also the impact of technical developments of medical equipment, and network technologies with mobile devices. The possibilities for inter-networking of medical devices and the development of sensor devices allow a seamless and permanent monitoring of the patient, at home and when they are mobile. In-home health-care and self management can provide improved health-care services for the actors involved, for patients e.g. with chronic diseases, while also offering security and safety.

Remote monitoring of vital signs using various sensor devices and ICT support for mobile healthcare teams are viable applications today, using specifically designed software. As the number and variety of medical devices as well as the number of providers increase, the design of platform independent infrastructures for interoperability are motivated. Many health-care related medical devices are also beginning to be available on the consumer electronics market.

The focus of Hydra will be on the service semantics and platform technology for integrated applications of medical devices of various types. The project will develop the necessary middleware for the interoperation of these and future devices. The middleware and related tools will be offered

to device manufacturers and designers of healthcare applications that may operate a wide spectrum of devices.

### 3.3 Agriculture

According to the European commission<sup>2</sup> the future big challenges of agriculture and food are

- *Sustainability*
- *Food quality*
- *Animal welfare*
- *Food safety*
- *Control mechanisms*

ICT plays a role in all of these challenges. For sustainability, ICT may help in meeting economical challenges (increased quality and quantity of food production) and ecological challenges, e.g., through precision farming. For food quality and food safety, ICT may, e.g., help in tracking food "from farm to fork". And new technologies for feeding, milking etc. help in raising animal welfare.

A challenge of ICT in agriculture is that of technical "silos" in which individual devices and systems help achieve parts of the tasks of farmers, but where there is little integration and communication.

The emergence of the PC in the late 1970s led to a proliferation of systems with promises of simplified accounting, paperless offices, automated process control and even systems that could think. Much of this promise has not been delivered. Developments in the UK for example typify these ICT expectations - where in 1984 there were sixty three companies claiming to provide specialist agricultural software to farmers and growers. Even IBM decided to move into the apparently huge market of 100,000 British farmers. Most of those companies soon realised that there were no fast bucks to be made and numbers fell back quite quickly to four or five specialist operators. However, the UK was different than the rest of Europe in that much of the development was through commercial software houses whereas most other countries relied more heavily on the education and research sector to provide software and systems. Farmers in mainland Europe seem thus to be more willing to try new systems and embrace new technologies, like decision support tools (Gelb 2006).

In the past 10 years, the use of innovative ICT has seen a rapid increase throughout mainstream Europe in almost every area of agricultural production and distribution.

Farm Management Information Systems allows for elaborate farm planning, easy tracking of performance, e.g. dairy cow programs providing analysis of individual animal performance data. One of the biggest drivers to use of farming Management Information Systems has been the increasing emphasis on recording for statutory purposes, quality assurance and traceability.

The use of the Internet to deliver information is still in its infancy in farming, but there is now clear evidence that most benefits come from frequently updated, rapidly changing information on prices, market reports and the weather. Farmers do not want unsolicited material pushed at them but emerging decision support tools can be used to more intelligently present this type of information.

Using *Geographic Information Systems* (GIS) to identify the position of any farm machine to a resolution of a few metres anywhere on the planet has intriguing potential but vision has in some respect moved ahead of reality. There is undoubtedly scope to adjust inputs either to take account of existing levels of say phosphate or potash or to modify nitrogen or spray regimes to reflect the yield potential. The problem is that many of the yield variations within a field are far from repeatable year on year because there are complex interactions between a host of variables like soil type, aspect, temperature, disease pressure, variety and sowing date. This means that the original predictions of being able to control automatically, the application of inputs using yield map data and clever agronomic software are some way off at present.

---

<sup>2</sup> [http://ec.europa.eu/agriculture/foodqual/index\\_en.htm](http://ec.europa.eu/agriculture/foodqual/index_en.htm)

Using computer systems to assimilate information and provide advice is perhaps the most exciting opportunity for the future use of ICT. The computer models can incorporate knowledge and expertise from many different specialists and can sift and apply a huge range of relevant information to arrive at suggested courses of action. Typical applications to date have included pest management in grain stores, arable crop disease control and grass seed mixture formulation.

The fundamental issue with ICT adoption in agriculture – as in most other industries as well – is the lack of real and perceived benefit to the user, i.e. the effort required to use a piece of hardware and/or software must be less than the benefit derived from its adoption. So we need to get better and devising systems which deliver real value to those, who we expect to use them – value they can understand in their terms.

Many examples of *Management Information Systems* applications are available on the market: Animal and herd registration, milk recording, quota management, milk analysis, fertility analysis, bull selection, grass measurement and budgeting, nutrient management, maps, tracking of inputs and outputs, numerous accounting applications, farm enterprise analysis, etc.

Software relating to all these topics and many other farming systems is widely available. The big question is then: Why don't more farmers adopt ICT on the farm? To alleviate this dilemma, much more coordination is required between equipment manufacturers, agribusiness and the professionals serving the farmer to achieve an integrated and harmonious approach.

The farmer is under siege from so much interesting and generally useful information that it is difficult for him to utilise it in a way that will benefit him in practical terms. It will have to become more targeted, more personal. What really interests him most is his own data: *my* herd data, *my* calf registration, *my* soil sample, *and my* payments! This is where the producers and holders of farmer information in electronic format can accelerate the process of farmer involvement in terms of building relationships to benefit both the farmer and the outside actors (Harsh 2005).

A large incentive at farm level could come from the e-government agencies accepting electronic data input for the various schemes and regulations they operate, benefiting both farmers and public bodies in terms of speed of data submission, accuracy and speed of payments. Since data collection and data input is a demanding and intimidating task for the farmer, the capability of co-operatives and other agribusiness organisations to download the farmer's own data on to his machine for automatic input to a particular program for analysis should help drive the uptake of ICT at farm level. But there is a serious problem facing users of advanced ICT networked systems. Exposure to the internet runs the high risk of abuse and of invasion of privacy from an incredible range of menaces and threats. Solutions to this increasingly important dimension must be factored into the services being offered to farm users.

*Traceability* along the food supply chain is basically the combination of two processes: intra-enterprise traceability and inter-enterprise traceability (Waksman 2003). If enterprises working in the same sector adopt different ways to describe the input, the production processes, and the output, it will not be possible to communicate information either to providers or to consumers.

Consequently, it is necessary to focus on the adoption of common data references at enterprise level (the farm), to describe e.g. crop protection chemicals, implements, interventions, analysis (soil, milk, etc.) in a consistent way. As traceability at intra-enterprise level is becoming established, traceability at inter-enterprise level may be seen as totally linked to logistics that makes it necessary to have a precise identification of all products. As far as information about these products is concerned, three options are most often considered:

The first type is information of a proprietary nature. It remains at the enterprise level, and will be published only when a problem occurs. This is the basis of most available traceability systems today.

The second type of information is freely transmitted along the chain e.g. to guarantee the food quality. In this case, the role of the Internet for low-cost information exchanges is increasing.

The third type of information is managed by neutral third parties, which develop proprietary multilingual and multi-actor information exchange platforms, where producers and distributors can publish the history of the products that they produce and distribute. The success of such platforms remains questionable today and will depend on the attitude of the main distribution networks.

A first choice has to be made between PC based solutions and / or Internet solutions. PC based solutions are almost exclusively marketed by well-established agricultural ICT companies whereas Internet based solutions are offered both by "newcomers" and well established ICT companies.

Care should be taken when implementing solutions of traceability at the farm level. Farmers own expectations should be taken into account in order to avoid that the traceability is weak or even wrong. It has also to be kept in mind, that most farmers are not very used to ICT technologies and sometimes act reluctantly with implementation if new systems.

Efficient solutions need to be based on a free choice of technical implementation combined with information feed back: e.g. the evaluation by farmers of their own technical performances compared with those of other farmers.

*Dairy farming systems* probably are the most complex of the agricultural production systems. In most other systems, involving plants and beef cattle, inputs and outputs occur a few times per year and they relate to one or two products. In contrast, the dairy system is one in which inputs and outputs are continuous: e.g. milk, births, deaths, sales or purchases of animals, feed and labour costs. The outputs of the dairy system are varied, milk, meat and surplus animals. They are the outputs of individual cows, the cost of which makes them individual production units that vary in performance. Maximizing revenue requires continuous decision making at both individual cows and herd levels, which can only be properly carried out on the basis of data evaluation, if one excludes situations in which freedom of choice is limited. This system internalized a wide range of sophisticated hardware and software, which required a large investment. The presence of such investments indicates that response to information flow is greater in the dairy farming system than in other components of the agricultural sector. This is true however only for certain categories of dairy systems and of hardware or software.

*Precision Agriculture* or site-specific crop management can be defined as the management of spatial and temporal variability at a sub-field level to improve economic returns and reduce environmental impact with the main activities being data collection and processing and variable rate applications of inputs. The tools available consist of a wide range of techniques and technologies from information and communication technology as well as sensor and application technologies, farm management and economics.

The most common Precision Agriculture applications consist of software to generate maps (e.g. yield, soil); to filtering collected data; to generate variable rate applications maps (e.g. for fertilizer, lime, chemicals); to overlay different maps; and to provide advanced geostatistical features. The machinery companies that provide yield meters also offer software to generate yield maps and fertilizer companies provide software to generate variable rate applications maps. Some of the packages are very complicated for farmers to use and are fairly expensive, while others are considerably simpler and cheaper with fewer options.

A study shows (Fountas et al. 2006) that the practitioners of Precision Agriculture tend to belong to a younger generation and they cultivate larger areas than the average farmer. The average age of the Danish respondents was 43 years old and 46 for the American respondents. In Denmark, the average age of farmers in 2000 was 52 years old (Danish Agricultural Council, 2000) and in the USA in 2002 was 55.3 (USDA, 2002). Another particular aspect is that farmers are very reluctant in entrusting the data storage and data protection to entities outside the farm. 81 % of the Danish and 78% of the US Corn Belt farmers indicated that they would prefer to store the data themselves, while 88% of the American respondents would prefer not to store the data in a shared Internet-based database.

## 4 Devices

In this section we will survey some of the typical categories of devices that are used in the different application areas. The purpose is to get an understanding of the breadth of different device types and functionalities that the Hydra middleware needs to embrace. It is not the intention to give a complete product guide for the different areas but rather to highlight some characteristics of devices that will need to be considered by the Hydra middleware. We limit our survey to existing available devices and do not speculate in future devices that might be developed.

### 4.1 Building automation systems and devices

The use of embedded, networked intelligent devices is beginning to increase in the field of automation. We will shortly describe how far the development has progressed. There are several similar, related automation concepts being used - building automation, room automation, home automation, smart environments, intelligent buildings etc.

The typical use for automation solutions today is:

- *Climate control.* To provide a comfortable environment for the occupants of a room, home, or building.
- *Energy consumption.* Use of intelligent techniques for more efficient management of heating, cooling and ventilation systems in order to cut down on energy costs
- *Access control.*

A building automation system is a programmed, computerized, "intelligent" network of electronic devices that monitor and control the mechanical, heating, alarm and lighting systems in a building. The intent is to create an intelligent building and reduce energy and maintenance costs.

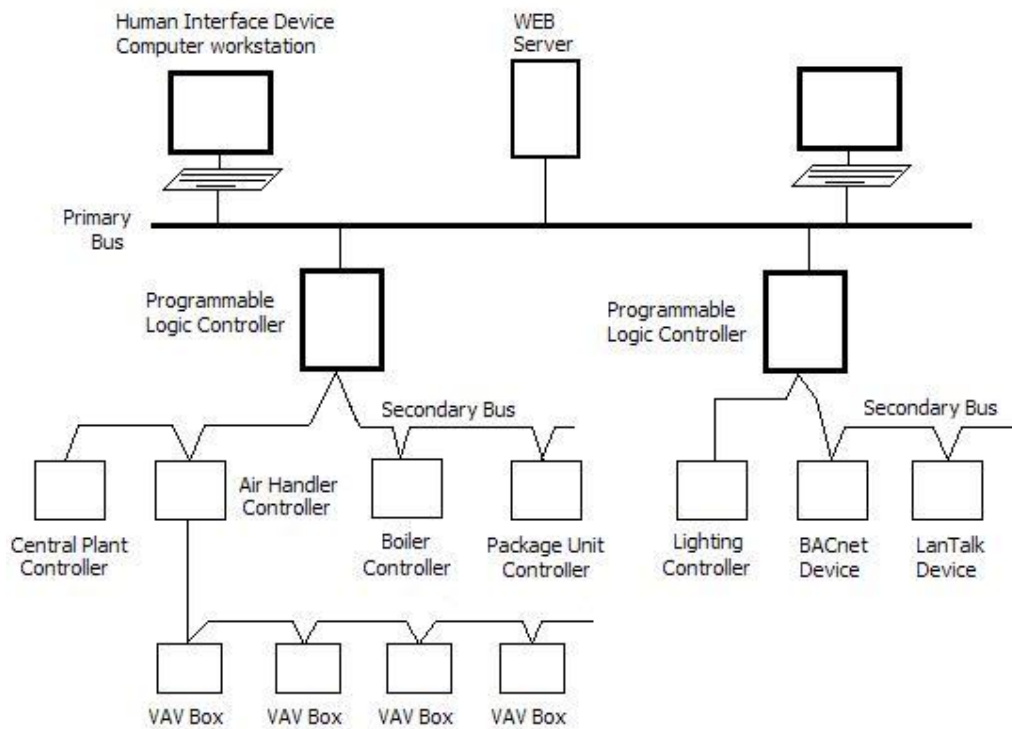

Some examples of different devices and systems that might be involved in a building automation

system are described below. The list is by no means exhaustive but gives an indication of the type of devices that the Hydra middleware needs to communicate and interact with.

For a more detailed description of device and products in the building automation domain we refer to Appendix B.

### **Controller**

The controller normally consists of one or more programmable logic controllers (PLC), often with custom programming. PLCs come in a wide range of sizes and capabilities to control devices that are common in buildings. Usually, the primary and secondary buses (see Topology below) are chosen based on what the PLCs provide.

Most PLCs provide general purpose feedback loops, as well as digital circuits.

### **Occupancy sensors**

Occupancy is usually based on time of day schedules. Override is possible through different means. Some buildings can sense occupancy in their internal spaces .

### **Lighting**

Lighting can be turned on and off with a building automation system depending on time of day, or the occupancy sensors and timers. One typical example is to turn the lights in a space on for half an hour after the last motion was sensed. A photocell placed outside a building can sense darkness and the time of day and can modulate lights in outer offices and the parking lot.

### **Air handlers**

Most air handler units (AHUs) mix return and outside air so less temperature change is needed. This can save money by using less chilled or heated water (not all AHUs use chilled/hot water circuits). Some external air is needed to keep the building's air healthy.

Analogue or digital temperature sensors may be placed in the space or room, the return and supply air ducts, and sometimes the external air. Actuators are placed on the hot and chilled water valves, the outside and return air dampers. The supply fan (and return if applicable) is started and stopped based on either time of day, temperatures, building pressures or a combination.

A central plant is needed to supply the air-handling units with water. It may supply a chilled water system, hot water system and a condenser water system as well as transformers and emergency power. If well managed, these can often help each other. For example, some plants generate electric power at periods with peak demand, using a gas turbine, and then use the turbine's hot exhaust to heat water or power an absorptive chiller.

### **Alarms and security**

Many building automation systems have alarm capabilities. If an alarm is triggered, the alarm system can be programmed to notify someone. Notification can be done via a computer, mobile phone or audible alarm system.

Common temperature alarms are Space, Supply Air, Chilled Water Supply and Hot Water Supply.

Differential pressure switches can be placed on the filter to determine if it is dirty.

Status alarms are common. If a mechanical device like a pump is requested to start, and the status input indicates it is off. This can indicate a mechanical failure.

Some valve actuators have end switches to indicate if the valve has opened or not.

Carbon monoxide and carbon dioxide sensors can be used to alarm if levels are too high.

Refrigerant sensors can be used to indicate a possible refrigerant leak.

Amperage sensors can be used to detect low amperage conditions caused by slipping fan belts, or clogging strainers at pumps.

At sites with several buildings, momentary power failures can cause hundreds or thousands of alarms from equipment that has shutdown. Some sites are programmed so that critical alarms are



automatically re-sent at varying intervals. For example, a repeating critical alarm (of an uninterruptible power supply in 'by pass') might resound at 10 minutes, 30 minutes, and every 2 to 4 hours there after until the alarms are resolved.

Security systems can be interlocked to a building automation system. If occupancy sensors are present, they can also be used as burglar alarms.

Fire and smoke alarm systems can be hard-wired to override building automation. For example: if the smoke alarm is activated, all the outside air dampers close to prevent air coming into the building. Life safety applications are normally hard-wired to a mechanical device to override building automation control.

### **Topology**

Most building automation networks consist of a *primary* and *secondary* bus which contains programmable logic controllers, input/outputs and a user interface.

The primary and secondary bus can be optical fibre, Ethernet, RS-232, or a wireless network.

Most controllers are proprietary. Each company has its own controllers for specific applications.

Inputs and outputs are either analogue or digital (some companies say binary).

Analogue inputs are used to read a variable measurement. Examples are temperature, humidity and pressure sensor.

A digital input indicates if a device is turned on or not. Some examples of a digital input would be a 24VDC relay or air flow switch.

Analogue outputs control the speed or position of a device, such as a variable frequency drive, a transducer, or an actuator. An example is a hot water valve opening up 25% to maintain a set point.

Digital outputs are used to open and close relays and switches. An example would be to turn on the parking lot lights when a photocell indicates it is dark outside.

See appendix B for an overview and examples of existing products within the building automation sector.

#### **4.1.1 Home Automation**

Home automation is a field within building automation, specializing in the specific automation requirements of private homes and in the application of automation techniques for the comfort and security of its residents. Although many techniques used in building automation (such as light and climate control, control of doors and window shutters, security and surveillance systems, etc.) are also used in home automation, additional functions in home automation include the control of multi-media home entertainment systems, automatic plant watering and pet feeding, and automatic scenes for dinners and parties. The main difference between building automation and home automation is, however, the human interface. In home automation, ergonomics is of particular importance, an issue which, among others, is pointed out in a recent "code of practice" for developers of intelligent home systems issued by CENELEC (CENELEC 2005)

	<b>User perspective</b>
	<p><b>The user interface delivers</b></p> <ul style="list-style-type: none"> <li>• Ease and joy of use</li> <li>• Attractiveness</li> <li>• Freedom for individual user needs (highly customizable scenarios)</li> <li>• Added value for families and single users (security, comfort, wellness)</li> <li>• Technology that simply works (reliability)</li> </ul>
	<b>Siemens perspective</b>
	<p><b>Strategic trendsetting, imaging and sales</b></p> <ul style="list-style-type: none"> <li>• Seamless integration of Siemens Smart Home components of different units</li> <li>• Consistent look &amp; feel delivers Siemens brand and quality / confidence of products to the customer</li> <li>• Harmonized UI concept ensures better time-to-market integration within TIH</li> </ul>

When home automation is installed during construction of a new home, usually control wires are added before the drywall is installed. These control wires run to a controller, which will then control the environment.

In a retrofit situation, or when installing control wiring is too expensive or simply not possible, there are wireless and power line communication protocols<sup>3</sup> such as X10, Universal power line bus, INSTEON, ZigBee and Z-Wave that will allow for control of most applications. Below these standards will be further described.

In extreme installations, rooms can sense not only the presence of a person but know who that person is and perhaps set appropriate lighting, temperature and music/TV taking into account day of week, time of day and other factors. Other automated tasks may include setting the air conditioning to an energy saving setting when the house is unoccupied, and restoring the normal setting when an occupant is about to return. More sophisticated systems can maintain an inventory of products, recording their usage through an RFID tag, and prepare a shopping list or even automatically order replacements.

Some practical implementations of home automation are for example when an alarm detects a fire or smoke condition, then all lights in the house will blink to alert occupants. If the house is equipped with a home theatre, a home automation system can shut down all audio and video components to alert the user to a possible fire or a burglar.



<sup>3</sup> Power Line Communication often referred to as PLC, not to be confused with the Programmable Logic Controller aka. PLC





*Home Automation: Controlling the lamp*

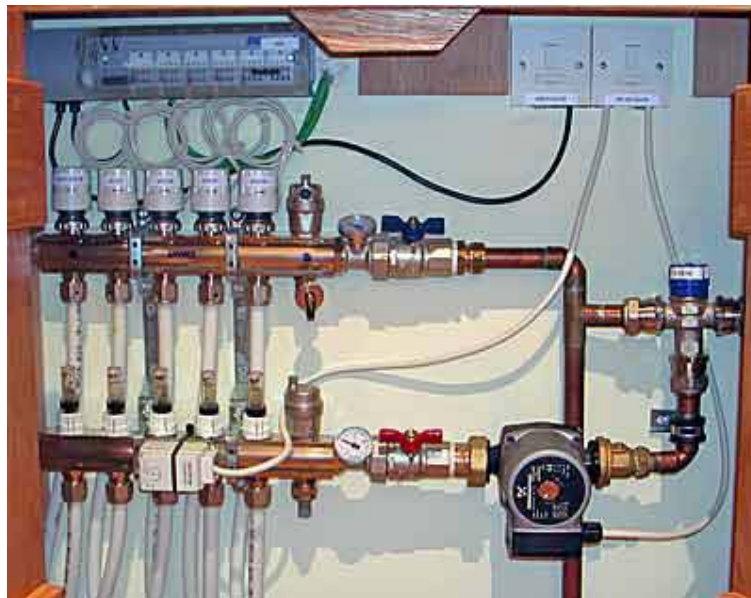

*Home Automation: Controlling the HVAC systems.*

Typical subsystems in a home automation system is HVAC (Heating, Ventilation and Air Conditioning), lightning control and security system (including cameras and movement sensors), but using special hardware almost any device electric or electronic can be controlled automatically or remotely. Including:

- Pool pump(s) and heater
- Hot tub
- Spa
- Coffee machine
- Pet feeder(s)
- Garage Door(s)
- Sprinkler System

In appendix A, the Hydra consortium partner TID describes their futuristic intelligent home installation called Casa Domotica.

### 4.1.2 Room Automation

Room automation is the consolidation of one or more manual system in a room under centralised control.

The most common example of *room automation* is corporate boardroom, presentation suites, and lecture halls, where the operation of the large number of devices that define the room function (such as Videoconferencing equipment, Video projectors, lighting control systems, public address systems etc.) would make manual operation of the room very complex. It is common for room automation systems to employ a touch screen as the primary way of performing operations.

### 4.1.3 Intelligent Buildings

Most intelligent buildings sense or manage several variables, or manage more than one building system, extracting greater performance than several disconnected building systems could achieve. Some form of network, or integrated information system seems to be required for a building to be called "intelligent". Simple thermostats are not considered intelligent, and neither are quite complex HVAC systems.

Most work on intelligent buildings concentrates on a particular subsystem. Building component manufacturers describe many improvements as "intelligent". Currently materials, structural systems, and boilers are all advertised as "intelligent" products or systems.

Engineers, architects and interior designers often use the phrase "intelligent building" to mean an office building with telecommunications that allow rapid reconfiguration of the interior layout for a client.

When engineers call a building intelligent, they often mean that computer programs coordinate many building subsystems to regulate the interior temperatures, HVAC and providing power. The goal is usually to reduce the operating cost of the building while maintaining the desired environment for the occupants.

Commercial-off-the-shelf Building Automation Systems (BAS) are available as discussed above. A basic BAS saves energy by widening temperature ranges and reducing lighting in unoccupied spaces. A BAS also reduces costs for electricity by shedding loads when electricity is higher-priced. Often, a building can be designed so that air-conditioning and refrigeration can be deferred.

Because many subsystems contribute to the costs of operating a building, customized building automation can be complex. Some intelligent building features include:

- Manage thermal transmissions through windows or walls.
- Anticipate forecasted weather, utility costs, or electrical demand.
- Learn and adapt to building occupants.
- Track individual occupants to adapt building systems to the individual's wants and needs (e.g. setting a room's temperature and lighting levels automatically when a homeowner enters).
- Detect and report faults in the mechanical and electrical systems, especially critical systems.

There are other, non-energy uses for automation in a building:

- Security.
- Rent or consumables charges based on actual usage.
- Giving directions within the building.
- Customized lighting to meet different needs, or set moods.
- Scheduling preventive maintenance.

## 4.2 Healthcare

The development of infrastructure technology for wireless and wired communications, together with the availability of new types of ICT-enabled devices, provide possibilities to enable changing or new forms of healthcare processes and in the organization of care. The increasing number of older patients as well as the increased citizen mobility are trends that can be met by the application of new mobile networks and devices technologies. This may support the development of care-chains, or shared care processes, where the individual's healthcare is the responsibility of a team of healthcare actors working across organizational care units within the healthcare system.

These trends are being accompanied by a very significant growth in home care, which is becoming increasingly feasible for chronically and serious ill patients. This is achieved through e-health services facilitated by intelligent sensors, monitoring devices, hand-held or wearable technologies, the Internet and wireless broadband communications.

### 4.2.1 Medical devices in Hydra

The Hydra project is concerned with ICT enabled medical devices which can be categorized as actuators, sensors, or processors that are installed and operated in the context of an ICT-application. Medical devices are encompassed by regulatory standards, EU directives and national certification procedures. These cover a very broad area of products intended for use within all areas of health and medical care. The range covers simple items such as plasters to large, advanced systems such as computerised tomography scanners as well as active implants such as pacemakers or handicap aids. A comprehensive overview of the regulatory standards pertaining to the health care application domain is provided in the Hydra standards watch deliverable (Hydra, 2006c).

Similar to the other Hydra application domains, a Hydra based Health application is foreseen to be based on a network of devices. These devices are connected, wired or wireless to communication hubs (or gateways), and may also move between gateways as a consequence of user mobility.

### 4.2.2 Sample devices

#### Wearable vital signs monitoring

The device below (Omron 637IT) is an autonomous and automatic wrist blood pressure monitor that can be connected to any computer via USB connection.



Omron 637T

Device properties:

- Measure systolic pressure (SYS), diastolic pressure (DIA) and heart rate (BPM), including the date in the storage for further study
- USB connection
- Memory for 90 measurements
- Alarm function. graph display for weekly overviews, large display showing blood pressure and pulse

The devices have a position sensor for optimal positioning to assure the highest accuracy. A built-in sensor determines the optimal height of the wrist; indicators on the display guide to the best position. Once put at the proper position, the monitor will automatically start the measurement. The

Another example is this upper-arm blood pressure monitor, with computer/printer connection. This device is also using a USB connection.

Device properties are:

- Memory capacity for 28 readings
- Large 2-fold display
- USB connection
- Clinically validated algorithm



Omron 750IT

[www.omron-healthcare.com](http://www.omron-healthcare.com)

Below is an example of a wrist-worn oximetry patient device that sends data to a small tabletop display. The wireless connection is based on Bluetooth. Device properties:

- Encrypted data transmission.
- 120 hours of battery life; 33 hours of memory.



Avant 4000 ([www.nonin.com](http://www.nonin.com))

### Digital plasters

Improving monitoring capabilities and usability of wearable medical devices has led to the design of "digital plasters", i.e., small sensor/transceiver devices attached to the body by means of plasters.

The digital plaster devices are used in wireless vital signs monitoring applications, including sensors for temperature, blood pressure and glucose levels.



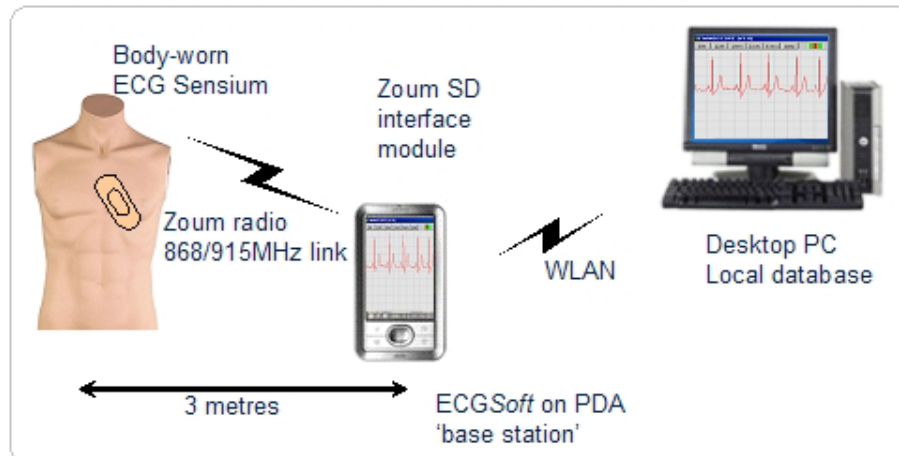

ECG Sensium wireless vital signs monitoring from Toumaz (<http://www.toumaz.com>)

### Portable/stationary devices

Propaq Encore offers a compact device for transport and bedside applications. The bright display provides patient vital sign waveforms and numeric data.

Device properties:

- ECG, heart/pulse rate, non-invasive blood pressure, motion tolerant pulse oximetry, impedance respiration, temperature.
- Full patient alarms and equipment alerts
- Programmable settings, RS-232 serial cable interface.



Propaq Encore

Additional options include up to two channels of invasive blood pressure, capnography (mainstream, side stream, or dual stream), and apnoea. The integrated printer option provides high-resolution, fully annotated, real-time printouts of three waveforms and numeric information for all active vital signs.

[www.monitoring.welchallyn.com](http://www.monitoring.welchallyn.com)

## 4.3 Agriculture

Agricultural equipment is often divided into three categories

1. Buildings
2. Livestock, e.g., cattle or pigs
3. Machines and plant production



The material used in this section is primarily based on a continuous state-of-the-art assessment in real settings, [FarmTest<sup>4</sup>](#), made by the [Danish Agricultural Advisory Service](#) ([www.lr.dk](http://www.lr.dk)). The assessment is quite comprehensive; there are, e.g., more than 50 tests within the cattle area. For the livestock category, we are here concerned with cattle.

Much of the building devices in the agriculture area are similar to those in the facility management area so we will not go further into describing these devices here.

### 4.3.1 Cattle

#### 4.3.1.1 Identification via transponders



Identification of cattle via transponders (RFID tags) placed on the animal is used in modern farm equipment, such as automatic milking and feeding, in numerous places. The image shows transponders from DeLaval.

#### 4.3.1.2 Activity measurement

Given the identity of an animal, various types of activity measurements may be performed. The device below is used to measure, if a cow is in heat. It communicates wirelessly (433.93 MHz, 70 meter range) with a herd management system that may then be used by the farmer to make decisions.

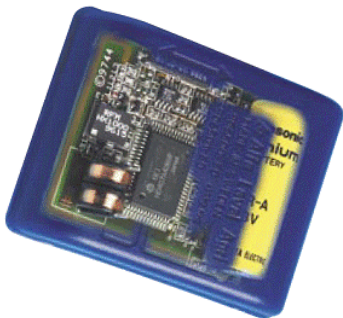

DeLaval ALPRO activity meter

#### 4.3.1.3 Climate control

There is facility management especially for cow stables. An example are automatic curtains for natural ventilation, that are controlled based on data collected by a weather station, for instance temperature and amount of rain. Below is shown an example curtain from Agrotel.



Agrotel automatic curtains



Weather station for controlling automatic curtain

<sup>4</sup> <http://www.lr.dk/applikationer/kate/viskategor.asp?ID=ka004000140000400>

#### 4.3.1.4 Cleaning

Depending on the type of stable, cleaning may be done automatically, e.g., by robots. The figure below shows an example of a scraping robot



Scraping robot

#### 4.3.1.5 Milking

Milking robots have been commonplace for several years. In 2004, 25% of all new Danish cattle stables were built with automatic milking equipment. Automatic milking equipment comes in a number of forms. The picture below shows a DeLaval milking carousel with room for 40 cows.



Computerized devices are also used before and after milking. A number of analyses (e.g., for germs) are performed for each cow based on its milk. Data may be logged. Also, separation equipment, that recognises the identity of the cattle, may separate cattle before milking (e.g., if they should not be milked) or after milking (e.g., if they should be inseminated). Further, the equipment typically has a way of raising a number of alarms (e.g., if malfunction of some part of the equipment is detected.)



Separation unit Separation unit (schematic)

Also in connection to milking, Cleaning-In-Place (CIP) equipment may clean the milking robot directly, reusing water and measuring levels of detergent, thus saving money and protecting the environment.



Strangko Milk-CIP

#### 4.3.1.6 Cattle care

An example of fully automatic cattle care is the Carematic hoofing equipment. It washes the rear hoofs with water and subsequently treats them.





Carematic hoof care equipment

#### 4.3.1.7 Cattle Feeding



Again based on identity of cattle, it is possible to construct automatic feeding systems that may also, e.g., use scales to weigh cattle and thus give an appropriate amount of food.

Happel X8 feeding system

A special case of cattle feeding is feeding of calves. Below, a stand-alone milk feeding automat that may again be coupled with weight measurements is shown.



Förster Stand-Alone 2000

### 4.3.2 Machines and plant production

#### 4.3.2.1 Position-based plant production

GPS information can be used in a large number of ways in plant production. Examples include position-based measurement of crop yield, soil quality measurements (e.g., via Geonics EM-38 as shown below), variable fertilization (also shown below), and variable planting.



Geonics EM-38



Hardi TY3500 with Raven injection

Heavy equipment should follow a controlled track in the field. Navigating machines along a defined path is another application for GPS.



User interface of tracking system. Diodes show actions that the driver should take.

#### 4.3.2.2 Vision-based devices

An example for the use of vision techniques in the field is optical sorting of potatoes. The AgriSep equipment (shown below) uses infrared light and measures reflection. Potatoes reflect light differently than stones and soil.



Optical stone sorting

The AGROCOM EYE-DRIVE, shown below, is another example of the use of computer vision that may be used to precisely steer equipment, e.g. to avoid damaging crops in rows.



AGROCOM EYE-DRIVE



#### 4.3.2.3 Crop analysis

Moisture analyzers often measure ground grain or seed in order to determine the moisture in crops. Harvesting crops with low moisture gives shorter drying time. An example of a device for such measurements is shown below.



Supertech Superpro moisture analyzer

The next picture shows a forage harvester that does automatic yield measurement during harvesting is shown. In this way, yield for a given area may be measured precisely.



CLAAS JAGUAR forage harvester





Yield measurement user interface

The AGROCOM CROP-Meter uses a mechanical pendulum mounted on the front of a tractor to measure amounts of crop.



AGROCOM CROP-Meter

#### 4.3.2.4 Communication in vehicles

Proprietary CAN<sup>5</sup> buses are used in modern tractors. ISOBUS (ISO 11783) specifies a standard communication system for agricultural equipment on top of CAN. It attempts to enable interoperation between on-board systems, tractors, and mounted implements. Major manufacturers such as John Deere and New Holland support the standard even though there is little equipment and few tractors that actually use the standard currently.

<sup>5</sup> Controller Area Network



John Deere ISOBUS-compatible GreenStar 2100 monitor

The absence of a ubiquitous communication standard implies that equipment often needs specific cables and equipment that is installed in, e.g., tractors. An advanced example of such a system is the HARDI HC 5500 for controlling the spraying of pesticides.



HARDI HC 5500 controller

#### 4.3.2.5 Vehicle guidance and control

Several systems for (semi-)automatic vehicle control exist. One example is again precision GPS



John Deere GreenStar AutoTrac SF1

The guidance systems may be designed specifically for a tractor brand or as an add-on to existing tractors. EZ-Steer (shown below) is an example of such a system.



EZ-Steer assisted steering system

## 5 Standards

This section exemplifies some of the standards (de facto and de jure) which are expected to have an impact on the Hydra platform in terms of implementation and compliance or have an influence on its design. These primarily include standards for device networking and interoperability. We refer to the Technology Watch Report (Hydra 2006a) and to D5.1 Communications Infrastructure Requirements (Hydra 2006d) for further overviews.

- X10 is an international and open industry standard for communication among devices used for home automation. It provides both wired, power line, and radio communications.
- [INSTEON](#) is a home automation networking standard including protocols, designed to address some of the shortcomings of X10. INSTEON is a (dual-mesh) network technology combining wireless [radio frequency](#) (RF) with power line communications, improving bandwidth and reliability compared to X10.
- KNX standard, a system for Home and Building Controls (promoted by "[Konnex Association](#)"), is open and platform independent. It guarantees multi-vendor and cross-discipline interoperability, ensured by certification and symbolized by the KNX trademark. The KNX standard supports many configuration methods (PC tools, device configurators and plug and play) and media (TP, PL, RF, Ethernet).
- Universal Plug and Play ([UPnP](#)) is a set of computer network protocols promulgated by the UPnP Forum. The goals of UPnP are to allow devices to connect seamlessly and to simplify the implementation of networks in home (data sharing, communications, and entertainment) and corporate environments. UPnP achieves this by defining and publishing UPnP device control protocols built upon open, Internet-based communication standards.
- Digital Living Network Alliance ([DLNA](#)) is an industry organization with members from the IT/telecom, PC and entertainment industries. The charter is to promote interoperability by developing standards and protocols for handling media and content in a digital home environment. The DLNA framework is largely based on UPnP.
- Jini (pronounced like "genie" and also called Apache River) is a service oriented architecture that defines a programming model which both exploits and extends Java™ technology to enable the construction of secure, distributed systems consisting of federations of well-behaved network services and clients. Jini technology can be used to build adaptive network systems that are scalable, evolvable and flexible as typically required in dynamic computing environments. Originally developed by Sun, responsibility for Jini is being transferred to Apache under the project name River.
- HAVi (*Home Audio/Video interoperability*) is a specification of several APIs that allows video and audio devices to interact without a PC as connector (control node). A disadvantage is the need for configuration that cannot be done by a final user. On the other hand, HAVI is well prepared to communicate with full-duplex devices that transmit high quality audio/video streams in real time, without interrupting other devices communication.
- [BACnet](#) is a network communications protocol for building automation and control systems.
- Digital Addressable Lighting Interface ([DALI](#)) is a digital protocol for the control of lighting in buildings, such as electrical ballasts and dimmers. [DSI](#) (Digital Signal Interface) is a precursor to DALI.
- [Dynet](#) consists of a standard RS485 serial bus. On the serial bus Dynet broadcasts using a proprietary 9600 baud eight-bit eight-byte control protocol. Along the same cable they also send low voltage power for devices that do not have a mains power connection. Each device contains its own "programmable logic controller" and follows the "peer to peer" model. The main advantage of this is that there is no



reliance on a single central controller. The system is capable of a high level of resilience and therefore well suited for situations where total failure could be a safety issue, such as lighting systems in public places.

- [LonTalk](#) is a protocol created by [Echelon Corporation](#) for networking devices.
- [ZigBee](#) is a short range, low-powered wireless communication standard targeted at Building Automation. A similar and competing technology is [Z-Wave](#).

Other forum and associations:

- OMA (The Open Mobile Alliance, [www.openmobilealliance.org](http://www.openmobilealliance.org)) is an industry alliance working towards specifications to ensure service interoperability over mobile devices, service providers and network architectures. Continues work previously endorsed by the WAP forum and Sync ML initiatives.
- [WWRF](#) (The Wireless World Research Forum, [www.wireless-world-research.org](http://www.wireless-world-research.org)) is a global forum set up in 2001, in order to promote research and identify trends in mobile and wireless systems. The forum currently has 150 members from both industry and academia, organized in a set of interest/working groups, with three annual summits<sup>6</sup>.
- [ASHRAE](#) (American Society of Heating, Refrigerating and Air Conditioning Engineers, [www.ashrae.org](http://www.ashrae.org)) is an international organization for people involved in heating, ventilation, air conditioning, or refrigeration (HVAC&R).

## 5.1 X10

X10 (<http://www.x10.org>) is an international and open industry standard for communication among devices used for home automation. It primarily uses power line wiring for signalling and control, where the signals involve brief radio frequency bursts representing digital information. A radio based transport is also defined.

The X10 standard is a power line communication standard, designed to allow remote switching on and off power consuming devices. The X10 standard is, however, limited in what X10 devices are required to do. It is mandatory that a device can be switched on and off, but it is optional for devices to respond to queries about their current state, i.e. whether it is on or off. X10 has a simple addressing scheme, consisting of a house code and a device code. Each code is 4 bits long, allowing a maximum of 256 devices to communicate.

X10 was developed in 1975 by Pico Electronics of Glenrothes, Scotland, in order to allow remote control of home devices and appliances. It was the first domotic technology and remains the most widely available.

Although a number of new higher bandwidth alternatives exist, X10 remains popular in the home environment with millions of units in use worldwide.

### 5.1.1 X10 Protocol

X10 control protocol data packets consist of a four bit "house code" followed by one or more four bit "unit codes". Finally, a four bit "command" follows. For the convenience of the users setting up the system, the four bit house code is labelled as one of the letters A through P while the four bit unit code is label as a numbers 1 through 16.

---

<sup>6</sup> <http://www.wireless-world-research.org/meetings/WWRF18/WWRF18-default.php>

When the system is installed, each controlled device is assigned to one of the 256 possible addresses (16 house codes \* 16 unit codes) and it will then only react to those commands specifically addressed to it.

In use, the protocol may transmit a message that says: "select house code A", "select unit 3", and "turn on" and the unit set to address "A3" will turn on its device. Several units can be addressed before giving the command, allowing the command to affect several units simultaneously. For example, "select house code A", "select unit 3", "select unit 5", "select unit 4", and finally, "turn on". This will cause units A3, A4, and A5 to all turn on.

Note that there is no restriction (except possibly consideration of the neighbours) that prevents using more than one house code within a single house. The "all lights on" command and "all units off" commands will only affect a single house code, so an installation using multiple house codes effectively has the devices divided into separate zones.

A full description of the protocol can be found at <ftp://ftp.x10.com/pub/manuals/xtddcode.pdf>.

## 5.2 EIB/KNX

<http://www.konnex.org/>

The purpose of KNX is to provide a network and interoperability standard for home and building automation. The KNX is a result of the convergence of previous European efforts in home automation and building control. The KNX specification has been derived from three existing systems for building control (EIB, EHS and BatiBUS), and provides an architecture for device networks including software tools for design and management of applications.

KNX has been approved (in 2006) as a CEN standard, as EN 13321-1, with reference to EN 50090. Parts of KNX (the medium independent layers) are also an ISO/IEC standard as part of the ISO/IEC 14543 series.

### 5.2.1 The KNX Standard: Communication media

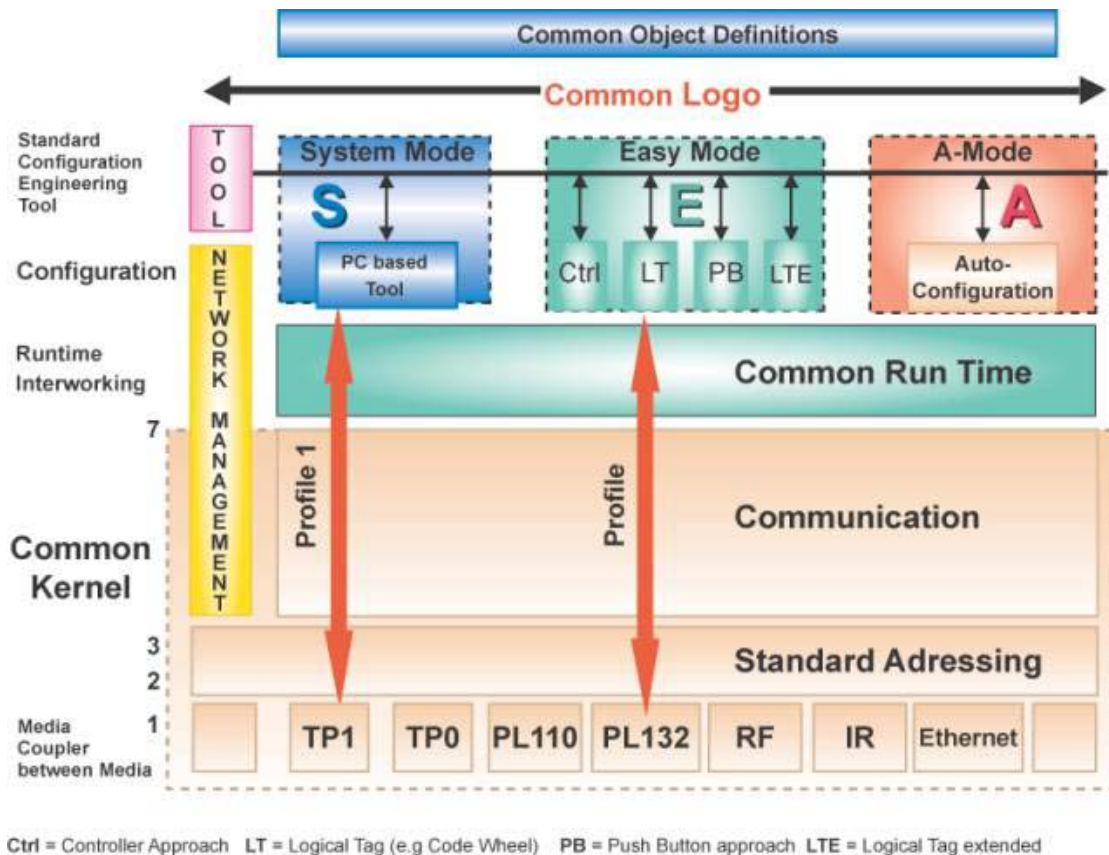

A manufacturer using the KNX can choose between different configurations and communication media. The standard provides three different configuration modes: for advanced installers, for medium trained installers and for end-users. Apart from the 3 configuration modes the **KNX** standard includes several communication media. Each communication medium can be used in combination with one or more configuration modes, which allows each manufacturer to choose the right combination for the target market segment and application.

#### 5.2.1.1 TP (Twisted Pair)

##### 5.2.1.1.1 TP-0 (Twisted pair, type 0)

This communication medium with 4800 bits/s bitrate has been taken over from BatiBUS. The KNX TP0 certified products will operate on the same bus line as the BatiBUS certified components but they will not be able to exchange information.

##### 5.2.1.1.2 TP-1 (Twisted pair, type 1)

This communication medium with 9600 bits/s bitrate has been taken over from EIB. The EIB and KNX TP1 certified TP1 products will operate and communicate with each other on the same bus line.

### 5.2.1.2 PL (Power Line)

#### 5.2.1.2.1 PL-110 (Power-line, 110 kHz)

This communication medium with 1200 bits/s bitrate has also been taken over from EIB. The EIB and KNX PL110 certified products will operate and communicate with each other on the same electrical distribution network.

#### 5.2.1.2.2 PL-132 (Power-line, 132 kHz)

This communication medium with 2400 bits/s bitrate has been taken over from EHS, where it is still used. KNX PL132 certified components and EHS 1.3a certified products, will operate together on the same network but will not communicate with each other, without a dedicated protocol converter.

### 5.2.1.3 RF (Radio frequency on 868 MHz)

This communication medium with a bitrate of 38.4 kbits/s has been developed directly within the framework of the KNX standard.

### 5.2.1.4 Ethernet (KNXnet/IP)

This widespread communication medium can be used in conjunction with the "KNXnet/IP" specifications, which allow tunnelling of KNX frames encapsulated in IP frames.

For a more detailed explanation of the various configuration media, please refer to the presentations of the [KNX Technology Tutorial workshop](#)<sup>7</sup>.

## 5.3 Universal Plug and Play (UPnP)

The UPnP architecture offers pervasive peer-to-peer network connectivity of PCs, intelligent appliances and wireless devices. The UPnP architecture is a distributed, open networking architecture that uses TCP/IP and HTTP. It enables seamless proximity networking in addition to data transfer between networked devices at home, in the office and everywhere in between.

It enables data communication between any two devices under the command of any control device in the network.

UPnP has a number of characteristics:

- *Media and device independence.* UPnP technology can run on any medium including phone lines, power lines, Ethernet, IR (IrDA), RF (WiFi, Bluetooth), and FireWire. No device drivers are used; common protocols are used instead.
- *Common base protocols.* Base protocol sets (Device Control Protocols, DCP) are used, on a per-device basis.
- *User interface (UI) Control.* UPnP architecture enables vendor control over device user interface and interaction using the web browser.
- *Operating system and programming language independence.* Any operating system and any programming language can be used to build UPnP products. UPnP does not specify or constrain the design of an API for applications running on control points. OS vendors may create APIs that suit their customer's needs. UPnP enables vendor control over device UI and interaction using the browser as well as conventional application programmatic control.
- *Internet-based technologies.* UPnP technology is built upon IP, TCP, UDP, HTTP, and XML, among others.

---

<sup>7</sup> [http://www.konnex.org/certification/tech\\_tut\\_ws\\_2004.php](http://www.konnex.org/certification/tech_tut_ws_2004.php)

- *Programmatic control.* UPnP architecture also enables conventional application programmatic control.
- *Extensibility.* Each UPnP product can have value-added services layered on top of the basic device architecture by the individual manufacturers.

The UPnP architecture supports zero-configuration, invisible networking and automatic discovery for a breadth of device categories from a wide range of vendors. Devices can dynamically join a network, obtain IP addresses, announce their names, convey their capabilities upon request, and learn about the presence and capabilities of other devices. DHCP and DNS servers are optional. A device can leave a network smoothly and automatically without leaving any unwanted state information behind.

UPnP relies on standardised DCPs (Device Control Protocols) that define the interface to different devices in an UPnP network. Current DCPs are:

- Audio/Video
  - [MediaServer V2.0 and MediaRenderer V2.0](#)
  - [MediaServer V1.0 and MediaRenderer V1.0](#)
- Basic
  - [Basic Device V1.0](#)
- Home Automation
  - [Digital Security Camera V1.0](#)
  - [HVAC V1.0](#)
  - [Lighting Controls V1.0](#)
- Networking
  - [Internet Gateway V1.0](#)
  - [WLAN Access Point V1.0](#)
- Printer
  - [Printer Enhanced V1.0](#)
  - [Printer Basic V1.0](#)
- Remoting
  - [Remote UI Client V1.0 and Remote UI Server V1.0](#)
- Scanner
  - [Scanner V1.0](#)

## 5.4 Device description

In order to support open and dynamic networks, the device protocols need to provide descriptions of the capabilities of the supported devices. This includes device identity and functional interfaces (services) and possibly also additional information such as details about the manufacturer, the model and the version.

Powerful instruments for device modelling and description are central in the Hydra architecture, as in all networks of devices and the "Internet of things". A number of efforts have been launched or are in pursuit to promote device modelling and management function to facilitate device interoperability in ambient intelligence environments similar to those to be supported by Hydra. The use ontologies

for device and service management has been proposed, e.g., the FIPA device ontology (FIPA 2002), the GAS Ontology (Christopoulou et al. 2005) and OWL device ontology (Bandara et al. 2004). A similar approach will be investigated in Hydra as part of the SOA and MDA design.

Similar to the application specific efforts like the EIB/KNX, several of the current industry forums and associations work to promote generic solutions for the management of (mobile) devices and services, such as The Open Mobile Alliance (OMA) in its working groups for mobile device management and mobile web services. The W3C has established the Device Description Working Group ([www.w3.org/2005/MWI/DDWG](http://www.w3.org/2005/MWI/DDWG)), working on a Device Description Repository (DDR).

As a concrete example of a current device description approach we briefly look at the device modelling and access as defined by the Device Control Protocols (DCP) of UPnP,



In this example the device (a Digital Security Camera) is described by a simple functional device model, showing the set of services this type of device may expose. In this case there are functions for accessing still and motion images as well as controlling basic camera settings (e.g., white balance).

The device description is represented in an XML structure following the UPnP device type format.

```

<root xmlns="urn:schemas-upnp-org:device-1-0">
  <specVersion>
    ....
  </specVersion>
  <URLBase>base URL for all relative URLs</URLBase>
  <device>
    <deviceType>urn:schemas-upnporg:device:DigitalSecurityCamera:1</deviceType>
    <friendlyName>short user-friendly title</friendlyName>
    <manufacturer>manufacturer name</manufacturer>
    <manufacturerURL>URL to manufacturer site</manufacturerURL>
    <modelDescription>long user-friendly title</modelDescription>
    <modelName>model name</modelName>
    <modelName>model name</modelName>
    <modelNumber>model number</modelNumber>
    <modelURL>URL to model site</modelURL>
    <serialNumber>manufacturer's serial number</serialNumber>
    <UDN>uuid:UUID</UDN>
    <UPC>Universal Product Code</UPC>
    <iconList>
      <icon>...</icon>
    </iconList>
    <serviceList>
      <service>..</service>
      .....
    </serviceList>
    Declarations for other services added by UPnP vendor (if any) go here
    </serviceList>
    <deviceList>
    Description of embedded devices added by UPnP vendor (if any) go here
    </deviceList>
    <presentationURL>URL for presentation</presentationURL>
  </device>

```

```
</root>
```

The above description provides a model template for the UPnP device type *DigitalSecurityCamera* identified by the *deviceType* URN defined by the UPnP standard.

The device description includes a list of service descriptions for the device functionality. A service list may be extended with manufacturer specific services in addition to the ones prescribed by the UPnP device type.

A service description list identifies each service by its service type and ID and list URLs for control and functions. The camera device type supports two services for camera control settings, access to still images and access to motion images.

```
<service>
  <serviceType>urn:schemas-upnporg:
service:DigitalSecurityCameraSettings:1</serviceType>
  <serviceld>urn:upnporg:
serviceld:DigitalSecurityCameraSettings</serviceld>
  <SCPDUURL>URL to service description</SCPDUURL>
  <controlURL>URL for control</controlURL>
  <eventSubURL>URL for eventing</eventSubURL>
</service>
<service>
  <serviceType>urn:schemas-upnporg:
service:DigitalSecurityCameraStillImage:1</serviceType>
  <serviceld>urn:upnporg:
serviceld:DigitalSecurityCameraStillImage</serviceld>
  <SCPDUURL>URL to service description</SCPDUURL>
  <controlURL>URL for control</controlURL>
  <eventSubURL>URL for eventing</eventSubURL>
</service>
<service>
  <serviceType>urn:schemas-upnporg:
service:DigitalSecurityCameraMotionImage:1</serviceType>
DigitalSecurityCamera:1.0 4
<serviceld>urn:upnporg:
serviceld:DigitalSecurityCameraMotionImage</serviceld>
  <SCPDUURL>URL to service description</SCPDUURL>
  <controlURL>URL for control</controlURL>
  <eventSubURL>URL for eventing</eventSubURL>
</service>
```

An individual service may have a set of state variables on which it operates, e.g., the default encoding for images. Any product, that exposes a device description referring to a specific UPnP device type, is required to implement mandatory descriptive elements and services as described in the corresponding DCP documentation.

The UPnP device template framework provides a fairly simple and open model for device description and service access. The model provides for extensibility through the XML-based description model.

#### 5.4.1 Classifying and registration of medical devices

As a basis for the consideration of medical devices in the Hydra device modelling framework, we should regard the directives and procedures regulating medical devices in the EU and internationally (the Hydra Standards Watch Report (Hydra 2006c) provides an overview of Hydra related regulatory standards).

The EU has issued the following directives that cover medical devices:

- Implantable Medical Devices Directive 90/385/EEC
- Medical Devices Directive 93/42/EEC



- In-Vitro Medical Devices Directive 98/79/EU

These directives stipulate the properties, testing and controls of medical devices. Under the EU Medical Devices Directive 93/42/EEC directive, a 'medical device' is defined as

*"any instrument, apparatus, appliance, material or other article, whether used alone or in combination, including software necessary for its proper application intended by the manufacturer to be used for human beings for the purpose of:*

- *diagnosis, prevention, monitoring, treatment or alleviation of disease,*
- *diagnosis, monitoring, treatment, alleviation of or compensation for an injury or handicap,*
- *investigation, replacement or modification of the anatomy or of a physiological process,*
- *control of conception, and which does not achieve its principal intended action in or on the human body by pharmacological, immunological or metabolic means, but which may be assisted in its function by such means."*

The EU provides a set of common guidelines (the MEDDEV) for the application of conformity procedures relating to the directives.

Details of the directives and guidelines are found on the EU medical devices web portal ([http://ec.europa.eu/enterprise/medical\\_devices/meddev/index.htm](http://ec.europa.eu/enterprise/medical_devices/meddev/index.htm)).

The national / international classification systems for medical devices are intended to ensure the operational safety and effectiveness of medical devices, based on national and international regulations and directives.

Device manufacturers are required to register device products in accordance with registration procedures (based in the directives) and the classifications. The EU provides a central repository (the EUDAMED database) with medical device information, including vendors, certificates and accident reports. This database is only accessible by the responsible authorities (e.g., national health agencies).

The Global Medical Device Nomenclature (GMDN) (<http://www.gmdn.org>) is a terminology system intended to enhance the interoperability of information on medical devices. The GMDN is a system developed for the classification of medical devices as defined in the three European directives mentioned above. The system has been developed by the European Standards body CEN within a project sponsored by the European Commission and with participation of the International Standards Organization (ISO) (ISO standard EN ISO 15225). The system includes 12 categories of devices., which form the basis for classifying products.



## 6 Conclusions

The Hydra platform will support the modelling, the management and the use of devices in an ambient intelligence environment. The developers are enabled to write software that controls and interacts with different devices. In this deliverable we have given a broad overview of the wide range of devices an application developer will be challenged with accessing and programming.

From the overviews in chapter 4 and 5, we conclude that embedded system technology will result in several different levels of intelligence and automation built into devices.

### Remote control of devices

This is the most straightforward way embedded systems technology and devices will be exploited. Physical devices will be made "intelligent" and will allow users to interact and control them remotely. This means for instance users can control devices from anywhere in their home, or even outside, through a mobile phone, PDA, home computer or intelligent displays, rather than having to be physically close to the device. In this level devices can be seen as "intelligent islands" of automation. They can be controlled programmatically but they are not aware of each other or interconnected and the device is controlled manually by an end-user.

This type of automation is already appearing in today's home automation applications and we also see it in some of the agriculture devices.

### Rule-based device control

A more advanced level of automation will allow users/developers to configure devices to execute their functions based on one or more programmed rules. Typical examples are rules like "when door opens, turn on light and ventilation". This allows developers to connect several devices and have them cooperate to provide a certain function. Here the devices are interconnected and can trigger each other, but it is under static rule control, i.e., the same thing will happen irrespective of the surrounding context.

This type of automation can be seen appearing in building automation and simpler eHealth solutions, which is quite often based on rules processing.

### Intelligent automation

This is the most sophisticated type of automation. Here, rule-based device control is combined with context awareness. This means, that devices can be configured and programmed using rules and context is also taken into consideration. Some examples would be:

- Lights are turned on when the door opens, but only if the home owner enters to the house.
- Ventilation is only turned on, if more than three persons have entered the room and stay there for more than 30 minutes.
- Blood pressure measurements from a wireless device are reported to a central system but only if they have been above a certain threshold for three consecutive measurements in a row.

This type of automation solutions are not available today and this is where Hydra will contribute. Although Hydra will support all sorts of device automation it is our ambition to provide support for developing true ambient intelligence solutions.

### 6.1 Towards a Hydra Device Ontology

Given the devices exemplified in chapter 4, there is a need to classify and describe devices according to their specific product functionality. We need to harmonise device descriptions in terms of their purpose and use, functional and operational characteristics, hardware and software capabilities, and more.

During the work in WP 6, these descriptions will be formalized into a device ontology which will be the foundation for automatically generating code that creates a software service around the device to allow programming and control of the device. This device service will be based on semantic web service technology.

The device ontology is considered as one of the model components in the Hydra MDA. This ontology with related semantic services will be used both at design- and in run-time. At design time (by users of the IDE/SDK<sup>8</sup>) e.g., by allowing developers to query on device properties and functions, in run-time the ontology will be used by the various services for device management (discovery, updates etc).

We foresee that a basic ontology support is part of the generic Hydra platform, with extension possibilities given to developers. A user (of the IDE/SDK) should be able to manually update a device ontology. The system should also provide a certain level of automated updates, by generating/updating ontology contents from device/product documentations. Similarly, detection of modifications made to a device (e.g., a vendor software upgrade) should be possible and result in updates of corresponding ontology elements. The ontology should support device versions.

There are a number of open issues with respect to the device ontology management, e.g., whether there should exist only a single (open, possibly distributed) device ontology or several ones, e.g., partitioned by device category or some other criteria, and how change management and ontology evolution should be realized. Further, the expressive power and inference capability of the ontology language and mechanisms need further investigation.

### 6.1.1 Basic considerations

We conclude this document with discussing the different dimensions along which we can classify our devices. The intention is to view this from a developer point of view, focusing the important characteristics of a device that need to be considered when programming against it. This will serve as input for future work in WP 3, WP 4 and WP 6. The purpose is to provide a first model of Hydra devices in terms of a basic set of device categories and their inter-relationships.

#### **Functional complexity**

As already described, devices differ widely in terms of their functionality. And from a programming point of view building an Hydra application will consist of managing and exploiting the functionality offered by the different devices. An important part of the envisioned device ontology will be to describe and model different device classes in terms of functionality. We need to distinguish between simple binary functionality like turning lamps on or off, and complex functionality like that of washing machines.

#### **Mobility**

An important characteristic is mobility. Is the device mobile or does it have a fixed location? A device that moves around, for instance if it is attached to a user's arm, requires the programmer to keep track of where the device is or the device must have the ability to return some location parameters.

#### **Robustness**

Robustness is another important characteristic. How does the device handle erroneous commands? When we are controlling physical devices programmatically, one can expect input sequences that do not occur when the device is controlled by manual operations. What happens, for instance, if a program issues a command to turn on the light if the lamp is already on? If there are physical restrictions to the commands that can be issued to a device some sort of protection mechanism needs to be in place to avoid physical damages to the device.

#### **Location dependence**

Is the device of a type that can only be operated in certain locations? Washing machines are normally not installed in the living room etc.

---

<sup>8</sup> Integrated Development Environment / Software Development Kit

**Resource consumption**

What kind of resources does a device consume and how much? If the device is operated by a battery and therefore have limited energy resources it might not be possible to constantly query/poll it for certain state variables like temperature. Therefore the middleware must support methods to avoid resource drainage, for instance caching mechanisms to avoid read out values all the time from the devices.

**State or stateless**

A typical programming problem is to keep track of and manage states. This is especially true when programming against devices and an important property of a device is if it can be in different states. Consider a washing machine that executes a number of washing steps. Depending on where in the washing cycle it is only a subset of commands will be available. This could be compared with a lamp that only has two states, namely 'on' and 'off'. A stateless device can accept any input at a random point of time.

Programmers will be faced with having to deal with inconsistent states. For example, a program could assume a lamp being off, although it is on.

**Querying**

How much can you query the device about its current state and variable values? If the device is not open or able to answer about its internal state, the programmer will have to try to keep track of that in his own program which will complicate the programming tasks.

**Sensor or actuator**

Some devices have the purpose of sensing data and providing these measurements to services. Other devices are instead acting and are controlling parts of their environment, either by themselves or by a user.

**Context awareness**

Is the device dependent on its physical environment? Does it have certain restrictions on temperature, humidity etc., in order to operate correctly?

**6.1.2 Design considerations**

There are a number of considerations to be made regarding the overall design of the device ontology:

- Required expressive power
- Requirements on inferencing and reasoning
- Support for (automatic) device classification
- Choice of ontology language(s)
- Principles for ontology evolution
- Support for ontology versioning

This will be further elaborated in workpackage 6.

**6.1.3 Implementation considerations**

There are a number of considerations to be made regarding the implementation of the device ontology:

- Performance
- Semantic security
- Context awareness

This will be further elaborated in workpackage 6.

## 7 References

- Bandara, A., T. Payne, et al. (2004). An Ontological Framework for Semantic Description of Devices. 3rd International Semantic Web Conference (ISWC2004). Hiroshima.
- CENELEC (2005). SmartHouse Code of Practice, CENELEC - European Committee for Electrotechnical Standardization
- Christopoulou, E. and A. Kameas (2005). GAS Ontology: an ontology for collaboration among ubiquitous computing devices, EU IST/FET - The Disappearing Computer.
- FIPA (2002). FIPA Device Ontology Specification. Geneva, FIPA - Foundation for Intelligent Agents.
- Eu-DOMAIN (2006), D2.5 Societal user requirements specifications (annex), eu-DOMAIN Project Deliverable, IST project 2003-004420.
- Fountas, S., S. M. Pedersen, et al. (2006). ICT in Precision Agriculture – diffusion of technology. ICT in Agriculture: Perspectives of Technological Innovation, ADAS Woodthorne.
- Gelb, E. and A. Offer (2006). ICT in Agriculture: Perspectives of Technological Innovation, ADAS Woodthorne.
- Harsh, S. B. (2005). Management Information Systems, Department of Agricultural Economics, Michigan State University.
- Hydra (2006a). D2.2 Initial Technology Watch Report. Hydra Project Deliverable, IST project 2005-034891.
- Hydra (2006b). D2.1 Scenarios for usage of HYDRA in 3 different domains. Hydra Project Deliverable, IST project 2005-034891.
- Hydra (2006c). D2.3 Initial Regulatory Standards Watch Report. Hydra Project Deliverable, IST project 2005-034891.
- Hydra (2006d). D5.Communications Infrastructure Requirements. Hydra Project Deliverable, IST project 2005-034891.
- Oberle, D. (2006). Semantic Management of Middleware, Springer.
- Waksman, G. (2003). The situation of ICT in the French agriculture., Proceedings of the EFITA 2003 Conference. Debrecen.

# Appendix A: Casa Domótica – an Example of Intelligent Homes

## A.1 Introduction to the Casa Domótica

In this appendix we will describe an existing demonstration facility for an intelligent home. It is being developed by Telefonica in Spain which is one of the partners in the Hydra consortium. The purpose of Casa Domatica is demonstrate how various device and communication technologies can be combined to provide services to the house inhabitants.

Apart from the traditional telephone line and TV, the Casa Domótica (domotic house in Spanish) includes the following elements:

- DSL broadband line: useful for services like "Video on demand", "Music *a la carte*", as well as "Security Surveillance" and "Medical Assistance"
- Data network: it allows interconnecting the different devices, connecting to the Internet in any room, as well as using the telephone, all at the same time.
- Multimedia network: to connect the TV, VCR, DVD players and watch it in any room in the house.
- Domotic network: some tasks can be done automatically by the use of sensors
- Residential Gateway: used to interconnect the DSL with the public broadband networks. It manages the security aspects.

Although these are many different networks, they can be implemented with just three kinds of physical networks. And the cost is slightly higher than that of a traditional house.

## A.2 Main services offered

Among others, the Casa Domótica provides the following services:

- Improvement of the personal security
- Improvement of installations security
- Saving time
- Saving energy
- Appealing offers for leisure

We can divide the services into three main groups:

1. Communications
2. Entertainment
3. Digital Management

These are discussed in the following subsections.



### A.3 Communications

- Videoconference: allows communicating with one or more people.



- LAN domestic network: allows connecting the different devices such as a PC, printer, webcam, etc.
- Unified messenger service: allows PDA users, mobile users and PC users to send messages among each other in a simple way.
- Telecommunication: allows the user to work at home.
- Online shopping, e-Commerce, Online Banking: These services allow the user to buy and sell products and manage money transfers.

### A.4 Entertainment

- TV and Video on demand: the user will have the possibility to choose the TV shows and movies he wants to watch. The entertainment system also allows using movies like a DVD: forward, look for a scene, stop it, etc.
- Stereo System: it includes the normal features of a stereo system, plus Internet channels (with streaming technology). It can play music from a CD, an Internet server, or a PC in any room of the house.



- Interactive TV: it allows the user to watch his favourite programs, send emails, check his bank account status, or the results of the last soccer match etc.
- TV *a la carte*: by the use of PVR (Personal Video Recording) the system will record any TV show that can be played any other time by the user.
- Game renting: the user will have access to a game platform, which enables him to rent a wide range of games for a limited period of time. The access to videogames can be denied for children.
- On-line gaming: users will be able to connect their consoles and PCs to play against others through the broadband. This includes two possibilities:
  - Game servers: every user has his own copy of the game and connect to a central server.
  - Persistent universes: there is no physical copy of the game. The user connects to a web site that supplies the necessary items to play. These kinds of games recreate virtual worlds that are uploaded constantly. The user will pay a monthly rate to play.

#### A.5 Digital Management

These services comprise all that is related to the management of the functioning of devices and to control the house status or the community. This can be performed locally, from a mobile, Internet,

or any other remote way.



#### e-Healthcare

These services will help people with special needs using telecommunications means. In a basic case, some equipment like "panic buttons" will be provided in necklaces or bracelets, as well as hands-free telephones. In a more advanced stage, the services will include some cameras that allow checking the state of the person in case of emergency. It will also allow the emergency team to enter the house. Also measurement devices can be used to send data to a medical centre, and have a continued supervision of the patient.

#### Comfort

This feature allows a better lifestyle by decreasing the amount of housework, increasing the security of its inhabitants, and providing information about the consumes:

- Access control: remote control of the lights, reading of counters, control of the alarm system.
  - Lighting control by presence detection
  - Automatic blinds and awnings
  - Lifestyle programs
  - Energy control and management
  - Electronic access – video porter
  - Guests control – access profiles
- Control of the alarm system:
  - Gas escape, water escape, smoke and fire detection
  - Automatic warnings (telephone, text, e-mail)
  - Automatic preventive actions (close of water, gas, open the blinds)
- HVAC (Heating Ventilating Air Conditioning)

- HVAC control via any PC, mobile phone or PDA
- Watering system control



•  
Electrical Appliances control and diagnose – energy saving

- Turn on/off of electrical appliances
- The appliances connected to the home network allow saving energy/money by using night rates.
- On-line diagnose of appliances

Counters remote reading

- Remote reading of water, gas and electricity counters, either at home, or in the community.

Security

- Non-professional surveillance: any part of the house can be watched via the Internet by the user. Also the installation can be done by the user with a set of cameras, sensors and the DSL. There is also a possibility of looking after children remotely or check who is at the door from a TV or PC.
- Remote security: the service of a company, together with a set of alarms and sensors, will solve any kind of water/gas escape as well as problems with intruders.
- Professional surveillance: any kind of problem is communicated to the pre-set phone numbers (usually an alarm management centre). It also permits to see any area of the house from the Internet.

**A.6 Enabling technologies**

To provide all these services to the end-user, multiple technologies are needed. Here, we will describe all these technologies, not only the ones needed indoors, but also the ones that allow to access the domotic house. Another essential technology described below, is the way the home network and the extern network are connected (Residential Gateway).

## A.7 The always-on home

The massive development of broadband accesses is making possible the permanent connection of the home, as well as changes in the lifestyle, towards an "on-line" world.

The networks that once were independent now are part of a bigger network to supply more services. Nevertheless, for its proper development, there are several requirements:

- Broadband (DSL): apart from the inner network, also the external one must provide a wide band for communications.
- Always-on: the permanent connectivity allows not establishing a call (in the traditional way) every time data is needed to be send. This feature is very useful for communications in which, low amount of data is send, but very often.
- Mobility and ubiquity: indoors, the user will be able to move with the freedom of cordless devices. There are many technologies that implement this, like DECT (*Digital Enhanced Cordless Telephony*), WiFi, WLAN, etc. For the ubiquity, IP will be used, in order to guarantee the access to any services in any place with any terminal.
- Security: this refers to the need of protection of the information that is to be sent.
- Independent from other services: It is essential that a technology is not focused only in one kind of service, but opened to many others.

## A.8 Access technologies

This section describes the main technologies that supply an access to a broadband from the outside to the inside of the house, interacting with many other networks.

### Wired Always-on Technologies

These technologies use physical means along which the information travels. The main advantage is that they need to be found to be accessed, therefore, they are very secure.

- DSL: it allows fast communication in both senses
- ADSL (*Asymmetric DSL*): it belongs to the DSL family, and their main characteristics are that the download and upload speed are different. The main services it gives support to are:
  - Voice+data over the same copper line
  - IP access at high speed
    - High speed Internet access
    - VPN (*Virtual Private Network*)
    - Telecommute
  - Other elements: splitter, user modem, server modem.
- HFC (*Hybrid Fibrid Coaxial*): it is used to distribute TV services
- PLC (*Power Line Communications*): it allows to send data using the electricity wires
- ADSL+ : second version of the traditional ADSL
- VSDL (Very High bit rate Digital Subscriber Line): DSL technology that can achieve 52Mbps.
- Optic Fibre and Ethernet.

### Wireless Always-on technologies

These technologies have the following advantages:

- Reduction in the deployment costs

- Reduction in the deployment process to the community
- Easier to deploy
- Incremental deployment according to the needs of the users
- The wireless systems are easier to protect from burglars

We can differentiate between:

- **Wireless Access:** similar to cellular access, only in this case, the terminal is not moving, but fixed in a certain location.
  - **LMDS (*Local Multipoint Distribution Services*):** allows in a radius of 4km to send data at high speed from a point to many, and the other way round.
  - **MMDS (*Multichannel Multipoint Distribution Services*):** similar to LMDS but working on a lower frequency, and a radius of 10km.
  - Wireless IP
  - FSO (*Free Space Optics*)
- **Cellular Access:**
  - **GPRS (*Global Packet Radio Service*)** it's an evolution of GSM that does not require high costs and reuses the current GSM infrastructures. It adds some new features like:
    - Transfer speed of up to 144 Kbps
    - Always-on connection
    - The cost is in proportion to the amount of data sent, not to the time of connection
    - Includes the packet mode, which is, it adapts easily to the communication protocols used in the Internet.
  - **UMTS (*Universal Mobile Telecommunication System*)** is the next step of GPRS.
    - It allows sending bigger amount of data, and a more efficient radio interface.
    - It requires a new infrastructure, a new network of higher capacity and new terminals.
- **Satellite Access:** It provides with global solutions with relatively few infrastructures. In the future this technology will be used in domestic applications to provide access to places that are geographically difficult to access.

## A.9 Technologies for domestic networks

Domestic networks allow the communication between the different devices in the house, as well as with the outside through the Residential Gateway.

Due to the difficulty to interconnect the different networks in a house (data network, multimedia network, and domestic network) many technologies have been developed as have been described in chapter 5:

### Wired Always-on technologies

We can find several technologies to connect devices, but the Casa Domótica emphasizes the use of the IEEE 1394 standard (FireWire), i.Link technology and USB.



On the hand, in the Casa Domótica we differentiate between the *communication network* and the *domotic network*. The first one refers to the data exchange among devices, while the second one only includes sensors and actuators. The *domotic network* does not require a broadband due to its limited functioning. The tables below show a comparison of the standards discussed in chapter 5 and some of the pros and cons when applying them in a intelligent home environment:

Traditional Ethernet	PLC	HomePNA
Uses different protocols such as: TCP/IP, Netware, AppleTalk, VYNES	Uses the low tension wires to create a network	Uses the traditional telephone line
TCP/IP allows the communication between different OSs and hardware	Low deployment cost	Uses low frequency band compatible with voice and DSL
It requires to have a NIC in every PC	Easy to install	Maximum speed of 10Mbps
It requires to connect the PCs with type 5 wire, not longer than 100m	Guarantees interoperability among the <i>HomePlug Powerline Alliance</i> certified products	It allows to create an Ethernet using the telephone line
Maximum speed is 10Mbps		It allows to connect any device with an Ethernet interface to it

Konnex	LonWorks	X-10
Wide variety of physical means of transport, but normally it uses its own wires of twisted pair	Wide variety of physical means of transport	Uses the electricity wires that already exist in a house
Can be programmed in 3 configuration modes:	Requires the installation of the nodes along the network.	Low cost
- S-mode: the devices are installed and configured by an expert	Requires the configuration of these nodes by a professional	Wide range of devices
- E-mode: the devices are programmed in the factory, but the may need some configuration	Solid technology	Easy installation and configuration
- A-mode: installation and configuration are automatically done	<b>Domotic Network Standards</b> Very reliable	Need to replace the current switches for others compatible with X-10
	Highly recommended for industry environments	

### Wireless Always-on technologies

Although the home area may look small to need wireless technologies, they are more flexible, and industry is developing faster and more secure ones.

- IEEE 802.11: its main purpose is to resolve compatibility problems among the different manufacturers of WLAN. It can be compared with the IEEE 802.3 standard for traditional Ethernet networks. Some variations on this standard:
  - 802.11a: uses ISM 5GHz for voice and images, 54Mbits/s.
  - 802.11b: WiFi, uses ISM of 2,4GHz, 11 Mbits/s.
- Bluetooth: uses ICM of 2,4GHz and supports up to 720Kbps within a range of 10m (can be extended to 100m with a higher power). It is used for voice and data.
- IrDA (*Infrared Data Association*): the way the signal is sent forces to put the sending device and the receiving one in a line, and in a short distance. The main disadvantage is, therefore, environment and weather conditions. There are some variations:
  - IrDA-Data: communication in both senses with a speed of between 9600 bits/s and 4Mbit/s and within a range of 2m; needs an angle of less than 30° and no obstacle in between.
  - IrDA-Control: is used to connect mobile devices with a fixed station. The maximum distance is 5m with a speed of up to 75Kbit/s.

### A.10 Architecture and interconnection standards

There is a wide range of architectures and solutions in the market. Here are some of the most outstanding:

- UPnP: it uses the typical standards from the Internet such as HTML, HTTP, XML, TCP/IP, UDP, DNS, and LDAP in order to connect all the electronic devices from a house. It makes the connection simple by avoiding the user configuration, and self-discovering the devices
- Jini: the main idea is how the clients and the services know each other and interact as an "interests community". To connect a device to a Jini network it only takes to plug it in. Any connectivity schema can interact with Jini, as it is platform independent.
- HAVi (*Home Audio/Video interoperability*): it is the specification of several APIs that allows video and audio devices to interact without a PC as connector (control node). Its main disadvantage is the need of a configuration that cannot be done by a final user. On the other hand, is well prepared to communicate full-duplex devices that transmit high quality audio/video streams in real time, without interrupting other devices communication.

### A.11 The Residential Gateway

New services need to transfer data in real time and using different physical means. This is why a link between the inner networks and the access network is needed. This link will be referred to as "Residential Gateway", which is just an interface that receives signals from the outside and transmit them to the inner network, and vice versa.

Initially, this definition is quite opened, and anyone can promote it. There are some features, though, that it may have:

- Interoperability with any kind of device
- Be opened to future changes
- Support security management

Some features that is expected from a residential gateway include:

- Easy installation: the closer to *Plug&Play*, the better.
- Remote software upload: the service provider must be able to upload or upgrade new services, as well as configure them remotely.
- Networks support: it must have interfaces to broadband lines (>10Mbps), as well as for the narrowband (domotic network).
- Security: it must implement the following
  - Access security: authentication and authorization
  - Data security: VPN between gateway and provider, HTTPS
- Multiple service support: it must support the execution of parallel tasks, representing one service each. The broadband will be shared by multiplexing the line via IP or the application layer.
- Web monitoring: every user must be able to configure his Residential Gateway, supervise the applications and its state. Small HTTP or WAP servers will be needed.

There are two types of Residential Gateways:

- Broadband Residential Gateway. They are routers/hubs/DSL modem that adapts the data from the inner network the data in the outside network, using Ethernet interfaces, USB, 802.11b, HomePNA.
- Multiservice Residential Gateway. They supply with different interfaces for data/control networks with several technologies. They can perform services with real time requests.

In general, the Residential Gateway will distribute the incoming packed information to the destiny device, as well as to pack the information generated from them.

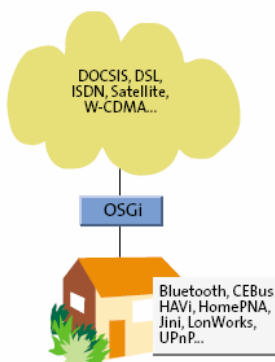

The OSGi (*Open Services Gateway initiative*) offers the minimum software architecture, so all the services can be executing without problems. It does not specify the hardware or the transport means, and is royalty free, so anybody can decide where and how to use it. It is a set of Java-based APIs that allow sharing services, managing data, resources, security and devices.

Some of the technologies that can be integrated in OSGi are: Jini, Plug&Play, UPnP, LonWorks, etc.

## A.12 The three domestic sub networks

This section comprises the three inner networks in a house.

### Data Network

It used to be the traditional phone line. Nowadays the users' needs have grown, so the network has evolved to a data network that not only allows making a phone call, but also to connect to the Internet in any point.

There may be several data networks in the same house, but they cooperate so the user only "sees" one.

### Multimedia Network

This network has been developed due to requisites in the amount of data and QoS. It is used to connect devices like a TV, video/DVD, game consoles, videoconference devices, etc. The inclusion of decoders will allow new interactive services like on-line banking, on-line shopping and on-line education.

But it is the field of the video games the most appealing for this network. The possibility of playing online defines new standards to upgrade/upload games, and paying rates.



### Domotic Network

Domotic services used to be unpopular in a recent past. But the situation is changing due to new standards, services at a reasonable price, bigger technological knowledge as well as a higher purchasing power.

The domotic network can supply basic services such as turning on/off switches remotely, controlling alarms, but it will also provide bigger services in a near future (on-line surveillance, on-line diagnose).

### A.13 Terminals

A first approach will differentiate between:

- Wall terminals: plasma TV
- Desktop terminals: PC
- Briefcase terminals: TabletPCs
- Hand terminals: PDAs, PocketPCs, SmartPhones
- Wrist terminals: devices to create a PAN

Nevertheless, from the point of view of the telecommunications, there is a different classification, according to:

- Mobility
- Broadband connectivity
- Dependence of the terminal with its content (games, video)
- Capacity of sending/receiving information through a gateway

In the following table we can appreciate the relation between services and broadband terminals:

Multimedia	Mobile (SMS,	PC	PD A	We b PAD	Table t	TV	Game Consol	ADSL Sound	Electrica l	On-line diagnos
------------	-----------------	----	---------	----------------	------------	----	----------------	---------------	----------------	--------------------

	Mobile	WAP)			PC		e	Syste m	Devices White Line	e	
<b>Communication s</b>											
Videoconference	**	*	** *	**	**	***	** *	*	*	*	*
Multimedia Messaging Service	***	**	** *	***	***	***	**	*	*	*	*
Broadband Via Satellite	*	*	** *	**	**	***	** *	*	*	*	*
Domestic LAN	**	*	** *	***	***	***	** *	***	***	**	*
<b>Entertainment</b>											
On-line gaming	**	*	** *	**	**	***	** *	***	*	*	*
Music a la carte	***	*	** *	***	***	***	** *	***	***	*	*
Digital TV (satellite)	*	*	**	*	*	**	** *	**	*	*	*
Video a la carte	**	*	**	*	*	**	** *	**	*	*	*
PC content a la carte	**	*	** *	**	**	***	**	**	*	*	*
On-line domotic portal for residence	***	**	** *	***	***	***	** *	*	*	**	*
On-line Sureveillance	***	**	** *	***	**	***	** *	*	*	*	*
Video-surveillance	**	*	** *	**	***	***	** *	*	*	*	*
Domotics and comfort	***	**	** *	***	***	***	**	*	*	***	*
<b>Other services</b>											
On-line diagnose	**	**	** *	**	**	***	*	**	*	*	***
Additional contents in the domotic portal	**	*	** *	**	**	***	** *	**	*	**	*
Broadband mobility service	***	*	** *	***	**	***	*	*	*	*	*
On-line education	**	*	** *	**	**	***	** *	*	**	*	*

## IAs (Internet Appliances)

Electronic devices to access the Internet are digital devices that provide an Internet service to the user. They have a friendly user interface, although their capability to be extended is limited.



The internet appliances in the Digital Home are the following:

- Mobile phone: wireless phone
- PDA (*Personal Digital Assistant*): personal agenda with similar PC functions
- Web Pad: allows internet access via a touch screen
- Countertop stations: similar to Web Pads with a bigger size and more functions
- STB (*Set Top Boxes*): adds services to a TV, such as Internet access and signal decoder
- Entertainment Gateways: similar to STBs, has more capacity and applications
- PVR (Personal Video Recorder): devices with a hard disk that can record video digitally
- IA phones (Internet telephones): similar to a normal mobile phone, with Internet access, email, and voice over IP
- i-Radios: apart from the traditional radio, includes an Internet service to download music and Internet radio
- Tablet PC: similar to a laptop, but with no keyboard
- e-mail: allows to connect to the mail system via a telephone line
- Photo Frames: devices similar to frames that allow to watch digital pictures
- Games consoles: they allow on-line gaming
- Electrical appliances: with the traditional functionality plus energy saving, security and comfort
- Devices for domotic applications: they receive and analyse the signals from the domotic network. They can communicate with an alarm centre, and also with the sensors
- On-line surveillance terminals: they allow to collect and send information about a patient's vital constants



## Appendix B: Automation Products and Suppliers

### Building Automation Systems

#### Desigo

Desigo is a complete building automation system from Siemens. It allows communication over Ethernet and TCP/IP. It supports BACnet, LONWORKS and KNX S-mode (EIB).

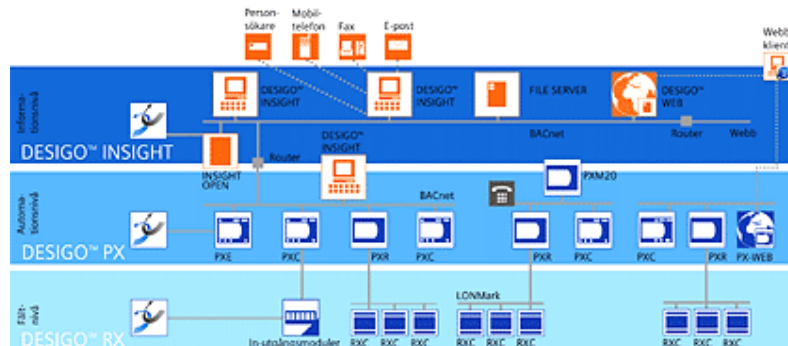

*The overall architecture of Desigo*

The most important system components are:

- Desigo Insight: Operator module
- Desigo PX: The automation system
- Desigo RX: Room Automation system
- Desigo Open for integration with other systems and devices

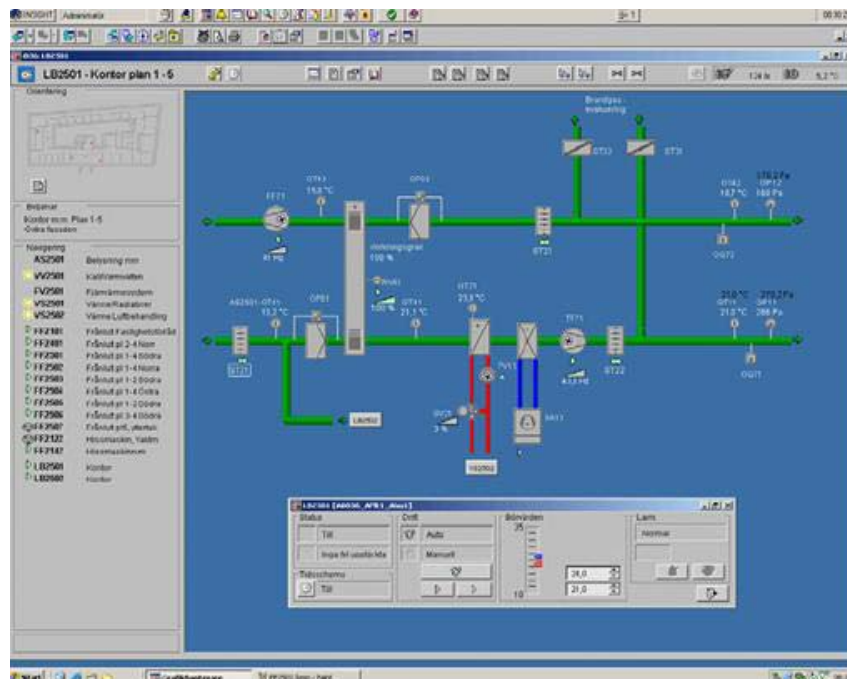

*The operator view of Desigo.*

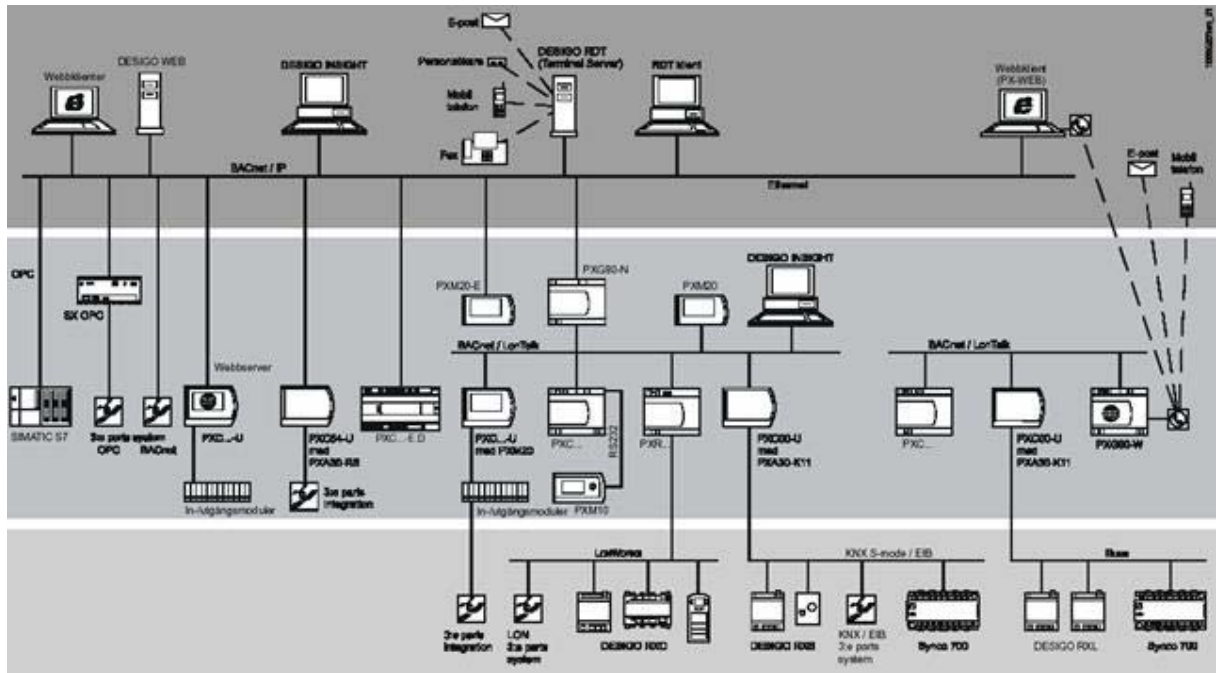

System-oriented view of Desigo PX

[http://www.siemens.se/sbt/BuildingAutomation\\_HVAC/sys/sys\\_des.asp](http://www.siemens.se/sbt/BuildingAutomation_HVAC/sys/sys_des.asp)

## EBI Enterprise Buildings Integrator

The Honeywell Enterprise Buildings Integrator (EBI) is a complete building automation system which uses open architecture and industry standards, EBI integrates 90 percent of all existing buildings systems, reducing or eliminating the need to replace existing HVAC or lighting control hardware. It consists of the following modules:

- *Building Manager* - Provides single-window control of HVAC, lighting, electrical equipment and more.
- *Security Manager*- Integrates building access and security systems in a single operator interface.
- *LifeSafety Manager* - Integrates building safety, protecting assets and occupants.
- *Digital Video Manager* - Integrates video with your enterprise systems.
- *Asset Locator* - Integrates tracking and monitoring of physical assets and personnel.
- *Energy Manager* - Integrates energy management across your entire enterprise.

[www.honeywell.com](http://www.honeywell.com)

## Control Units, DUC

### IQ3xcite

IQ3xcite from Geamatic is a computer sub central that is designed to communicate over Ethernet with TCP/IP. It has 10 universal inputs and 6 analogue outputs. It is possible from a web browser to control and manage the devices connected to IQ3xcite.



www.geamatic.se

### IP-DUC



IP-DUC from Automatikprodukter allows controlling, managing and regulating the building climate through a web browser.

### IMSE Webmaster

IMSE WebMaster from Abelko allows controlling, managing and regulating different device in a building through a web browser, see an example below of the user interface.

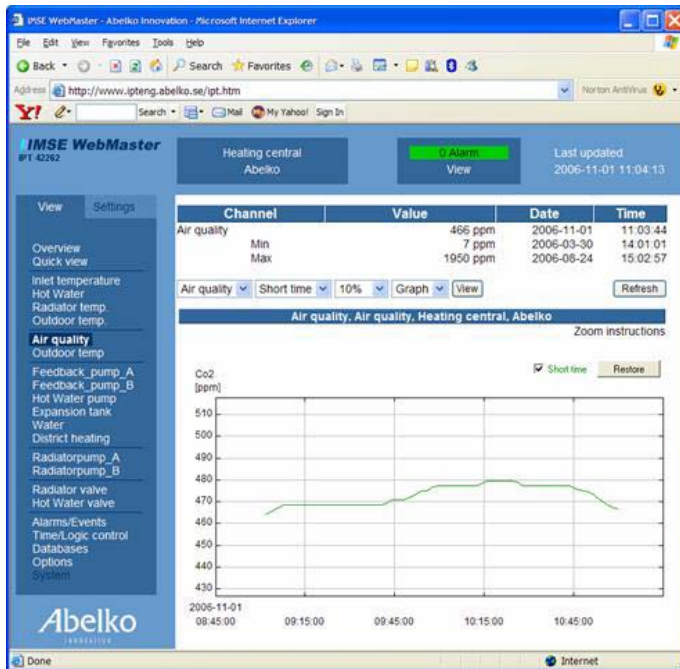

<http://www.ipteng.abelko.se/ipt.htm>

### BAS2

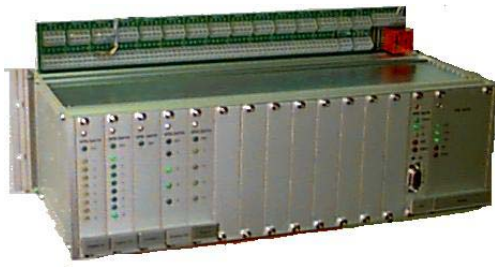

Bastec is a Swedish company delivering control units for building automation system that eliminates the need for a central computer.



[www.bastec.se](http://www.bastec.se)

## Home Automation

### HomeSeer

HomeSeer HS2 is a home automation and remote access software package that is designed to integrate the major systems of any home. With HomeSeer, you can control and monitor lighting, appliances, security, HVAC, telephone and home theatre all from one central point... and you can do so by computer, remote control, touch screen, PDA, telephone, the internet or by voice.

HomeSeer system software is compatible with wired and wireless protocols for easy adaptation to new construction or retrofit installations. Z-Wave wireless devices are fully supported as well as conventional power line-based solutions (like X-10)

HomeSeer integrates with Windows Media Center:



[www.homeseer.com](http://www.homeseer.com)

### Omni Pro II

Omni home control system from Home Automation Inc provides temperature and lighting control for energy savings, integrated UL-listed security for enhanced safety, and the telephone and Internet access and control.



It can be combined with HAI Home Control. It is a software that runs on a Windows Media Center computer for controlling lighting, temperatures, and security on a television using a single Media Center remote control.

A Windows Media Center coordinates music, television, and home photography for an enjoyable home entertainment experience. HAI's Home Control coordinates security, temperature, and lighting for comfort, convenience and safety.



[www.homeauto.com](http://www.homeauto.com)



## HomeWorks Interactive

HomeWorks Interactive, the world's leading whole-house lighting control system, provides simple, convenient control of all home lighting, as well as the ability to control audio, video, and many other sub-systems in a home.

Each light in a home can be controlled from any HomeWorks Interactive Keypad, providing instant access to all areas of the home and landscape. This eliminates the tedious task of setting the home lighting just right for daily activities, bedtime, or special occasions.



[www.ehchomes.com](http://www.ehchomes.com)

## Xanboo

Xanboo's technology enables local and/or remote access and control of virtually any type of device over the Internet. The software allows a user to control, command, and monitor devices from anywhere in the world using a standard web interface (PC, Cell Phone or PDA). In addition, the Xanboo's technology allows it to interface with third-party networking protocols such as ZigBee, Z-Wave, X10 or IP cameras.

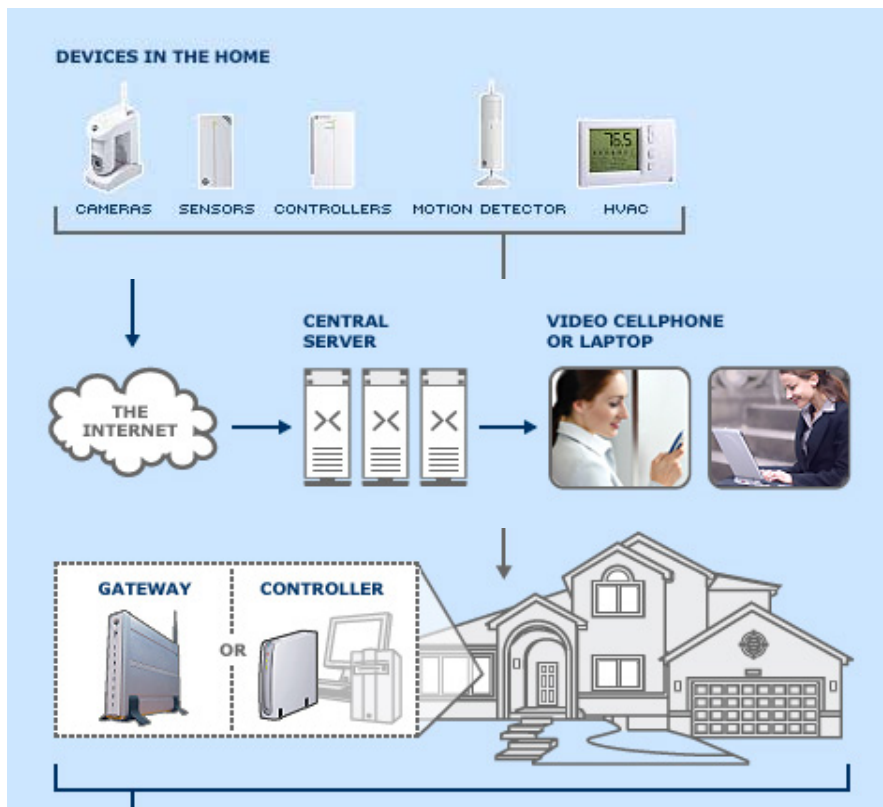



**PIPE Gateway**

The PIPE Gateway provides remote control of intelligent home appliances by connecting a power-line network to an Ethernet or WiFi network. This connection provides remote control of intelligent home appliances.

LAN on Ethernet or WiFi lets the home owner control his appliance network from a PC or PDA anywhere in the house.

WAN connected to an Ethernet network by a modem provides Internet and e-mail access to the appliances for distant service providers and for the owner away from home.

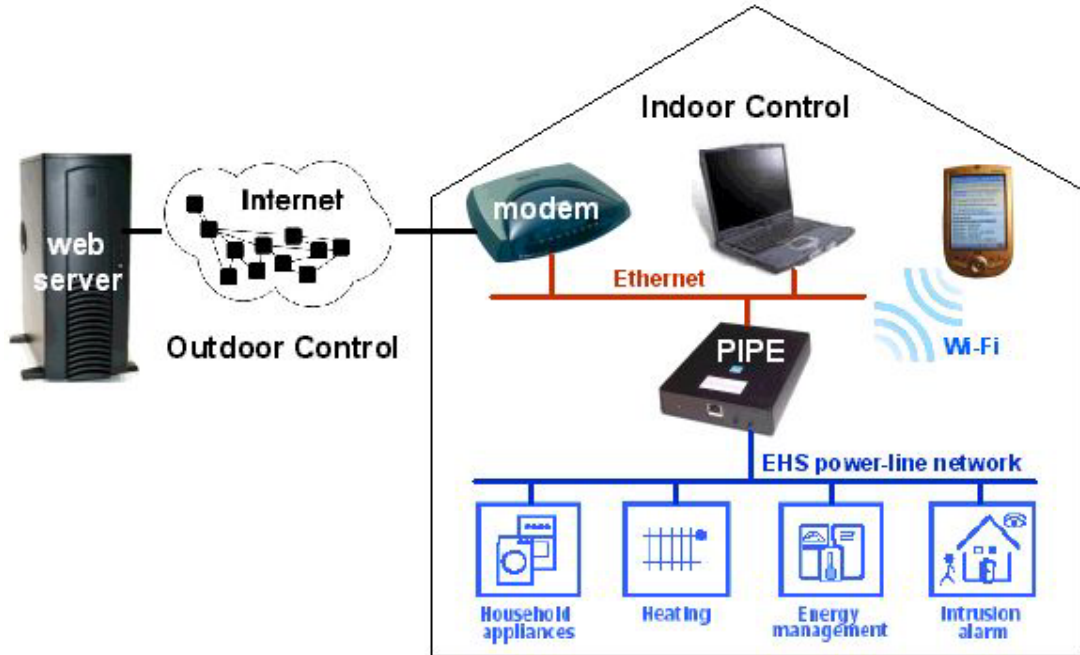

PIPE facilitates a wide range of tele-services such as control, monitoring, and diagnosis from a distance.

Remote Access Services	Target EHS Systems
<ul style="list-style-type: none"> <li>Monitor device status</li> <li>Configure appliances</li> <li>Send and receive commands</li> <li>Send alarms and warnings</li> <li>Request diagnostic data</li> </ul>	<ul style="list-style-type: none"> <li>Intrusion surveillance</li> <li>Fire &amp; smoke detection</li> <li>Warnings &amp; alarms</li> <li>Heating, cooling, ventilation</li> <li>Lighting, electrical installation</li> <li>Meter reading</li> <li>Household appliance control</li> <li>Energy management</li> </ul>

<http://www.trialog.com/HomeTech/PIPEgateway.html>

**Siemens serve@Home**

Is a general home automation system with gateways, enabled household appliances, special devices. It allows control either locally or remotely using the internet. Serve@home utilises the available Konnex standards.

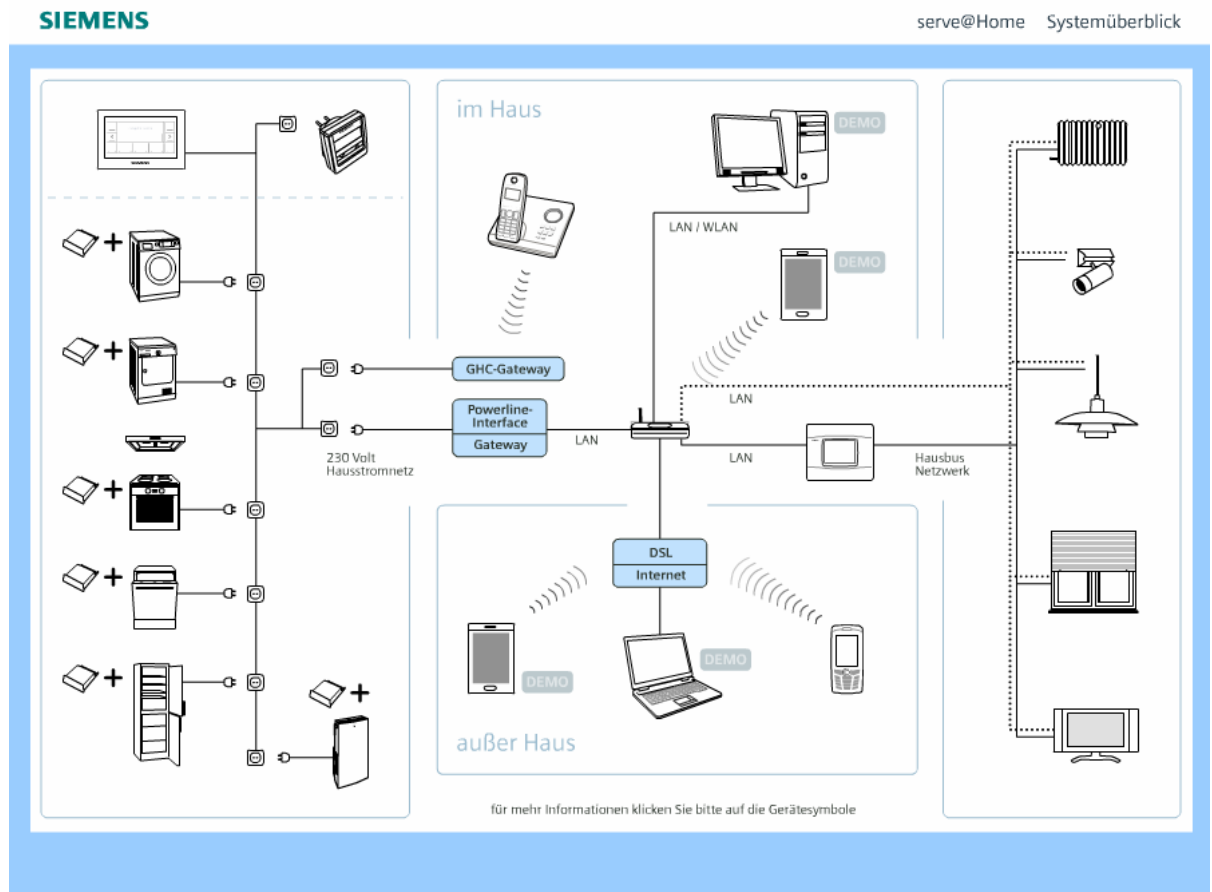

<http://www.serve-home.de/>

## My Home



My Home, developed by BTicino, consists of a range of integrated control systems for household appliances and systems. It supplements door intercom and video installations, security systems, air conditioning and lighting systems and scenario controllers. Its object is to enhance comfort and convenience and control energy consumption. My Home BTicino offers variations of form, colour scheme and materials from metal through various kinds of wood to plastics like polycarbonate and

ABS. Simple wiring, incorporating a central digital bus and a micro-processor in every control device, assures communication between all systems.



[www.bticino.com](http://www.bticino.com)

## Appendix C: European Home automation manufacturer overview<sup>9</sup>

Manufacturer	System	Distribution channel/ source of supply	Retrofit
--------------	--------	---	----------

Product group: **Server with access to house- and flat installations** (999,00 € - 1.100,00 €)

<a href="#">Siemens-Electrogeräte</a>	IP / LAN (Ethernet or WLAN)	10, 11, 16	serve@Home <a href="#">household appliances</a> can be equipped with system electronics.
<a href="#">Siemens</a>	div. possibilities of communication	5	yes
<a href="#">Viessmann</a>	div. possibilities of communication	15	yes
<a href="#">Gira</a>	EIB (wired / twisted pair)	5, 9	yes
<a href="#">Merten</a>	div. possibilities of communication	9	yes
<a href="#">Jung</a>	EIB (wired / twisted pair)	5, 9	yes, with present EIB-system

Product group: **PC / Terminal / Web-Tablet** (995,00 € - 1.100,00 €)

<a href="#">Gira</a>	EIB (wired / twisted pair)	5, 9	with present EIB-system only
<a href="#">Merten</a>	EIB (wired / twisted pair)	9	with present EIB-system only

<sup>9</sup> Source: <http://www.intelligenteswohnen.com/produkt.php?lang=de&id=13>

<a href="#">Jung</a>	EIB (wired / twisted pair)	5, 8, 9, 10	with present EIB-system only
----------------------	----------------------------	-------------	------------------------------

Product group: **Mobile phone / PDA** (1,00 € - 500,00 €, Price depends on usage and price model.)

<a href="#">Siemens</a>	GSM (Mobile phone system)	10	ja
-------------------------	---------------------------	----	----

Product group: **Infodisplay / display module** (129,00 € - 309,00 €)

<a href="#">Siemens-Electrogeräte</a>	KNX Powerline (EHS 1.3a)	10, 11, 16	<a href="#">serve@Home household appliances</a> can be equipped with system electronics.
---------------------------------------	--------------------------	------------	--

<a href="#">Miele</a>	KNX Powerline (EHS 1.3a)	10, 11, 16	Miele@home InfoControl, display module for communication enabled Miele <a href="#">household appliances</a>
-----------------------	--------------------------	------------	---

<a href="#">Jung</a>	EIB (wired / twisted pair)	5, 8, 9, 10	Yes, with present EIB-system
----------------------	----------------------------	-------------	------------------------------

<a href="#">Miele</a>	KNX Powerline (EHS 1.3a)	10, 11, 16	Miele@home, SuperVision, for use with prepared devices
-----------------------	--------------------------	------------	--

<a href="#">Miele</a>	KNX Powerline (EHS 1.3a)	10, 11, 16	Miele@home, SuperVision, Miele@home, SuperVision, for use with prepared devices
-----------------------	--------------------------	------------	---

<a href="#">Miele</a>	KNX Powerline (EHS 1.3a)	10, 11, 16	Miele@home, SuperVision, Miele@home, SuperVision, for use with
-----------------------	--------------------------	------------	--

			prepared devices
<a href="#">Miele</a>	KNX Powerline (EHS 1.3a)	10, 11, 16	Miele@home, SuperVision, Miele@home, SuperVision, for use with prepared devices
<a href="#">Siemens</a>	EIB (wired / twisted pair)	5, 10	with appropriate wiring

Product group: **Communication enabled household appliances** (50,00 €, additional costs per device; additional costs for the system)

<a href="#">Siemens-Electrogeräte</a>	KNX Powerline (EHS 1.3a)	10, 11, 16	serve@Home <a href="#">household appliances</a> can be equipped with system electronics.
<a href="#">Miele</a>	KNX Powerline (EHS 1.3a)	10, 11, 16	Miele@home, SuperVision, Miele@home, SuperVision, for use with prepared devices

Product group: **Gateways** (999,00 € - 1.000,00 €, Costs depend on system, application and configuration. Gateways built into devices increase the device's price.)

<a href="#">Buderus</a>	EIB (wired / twisted pair)	5, 15	Yes, with appropriate basic device
<a href="#">Hager Tehalit</a>	EIB (wired / twisted pair)	9	Yes, with appropriate basic device
<a href="#">Viessmann</a>	proprietary bus on 2-wire basis	15	Yes, with appropriate basic device
<a href="#">S. Siedle &amp; Söhne</a>	proprietary bus on 2-wire basis	2, 5, 9, 10	Yes

---

<a href="#">Merten</a>	EIB (wired / twisted pair)	9	Yes, with present EIB-system
<a href="#">Gira</a>	EIB (wired / twisted pair)	5, 9	Yes, with present EIB-system
<a href="#">Siemens</a>	EIB (wired / twisted pair)	5	Yes, with present EIB-system
<a href="#">ABB Stotz-Kontakt</a>	EIB (wired / twisted pair)	5, 8, 9	Yes, with present EIB-system
<a href="#">Siemens-Electrogeräte</a>	Ethernet (wired IP)	10, 11, 16	serve@Home <a href="#">household appliances</a> can be equipped with system electronics.
<a href="#">Siemens</a>	KNX wireless	5, 10	Yes
<a href="#">Siemens</a>	ISDN	5, 10	Yes, with appropriate wiring
<a href="#">Siemens</a>	IP / LAN (Ethernet or WLAN)	5, 10	Yes, with appropriate wiring
<a href="#">Siemens</a>	Ethernet (wired IP)	5, 10	Yes, with appropriate wiring
<a href="#">Siemens</a>	analogue phone	5, 10	Yes, with appropriate wiring
<a href="#">Jung</a>	EIB (wired / twisted pair)	5, 9	Yes, with present EIB-system
<a href="#">Stiebel Eltron</a>	proprietary wired bus system	9, 10, 15	With current heat pumps and local ventilation appliances
<a href="#">Viessmann</a>	EIB (wired / twisted pair)	15	Yes, with appropriate



basic device

Product Group: **Fernsehgeräte** (850,00 € to 3.000,00 €)[Loewe](#)

IP / LAN (Ethernet or WLAN) 11

Yes, via  
authorised,  
specialised  
trade